

ONLEVEL

ZÁBRADLÍ ZE SKLA



chlebny

# TL-6000

0.5 kN top mount

## TL-6000 - Our Ryu

The U-profile TL-6000 is the big challenger of all aluminum profiles and still has considerable installation advantages. Especially suitable for applications in the private sector and low-traffic buildings. The mounting distances have been increased and also you can use adjustable bolt anchors. Thus, the product is not only cheaper and faster in the assembly, but also the statics has improved significantly.

It can be used outdoors, withstands a linear load of 0.5 kN and is suitable for glass brands between 12 mm and 21.52 mm.

## Essential Features

- | Slimline, elegant design and low-maintenance
- | ONLEVEL FLEXFIT Glass Adjustment Tool
- | Drainage holes
- | For glass thicknesses between 12 - 21.52 mm
- | For applications with low loads



**TESTED**  
according to  
**BS6180**

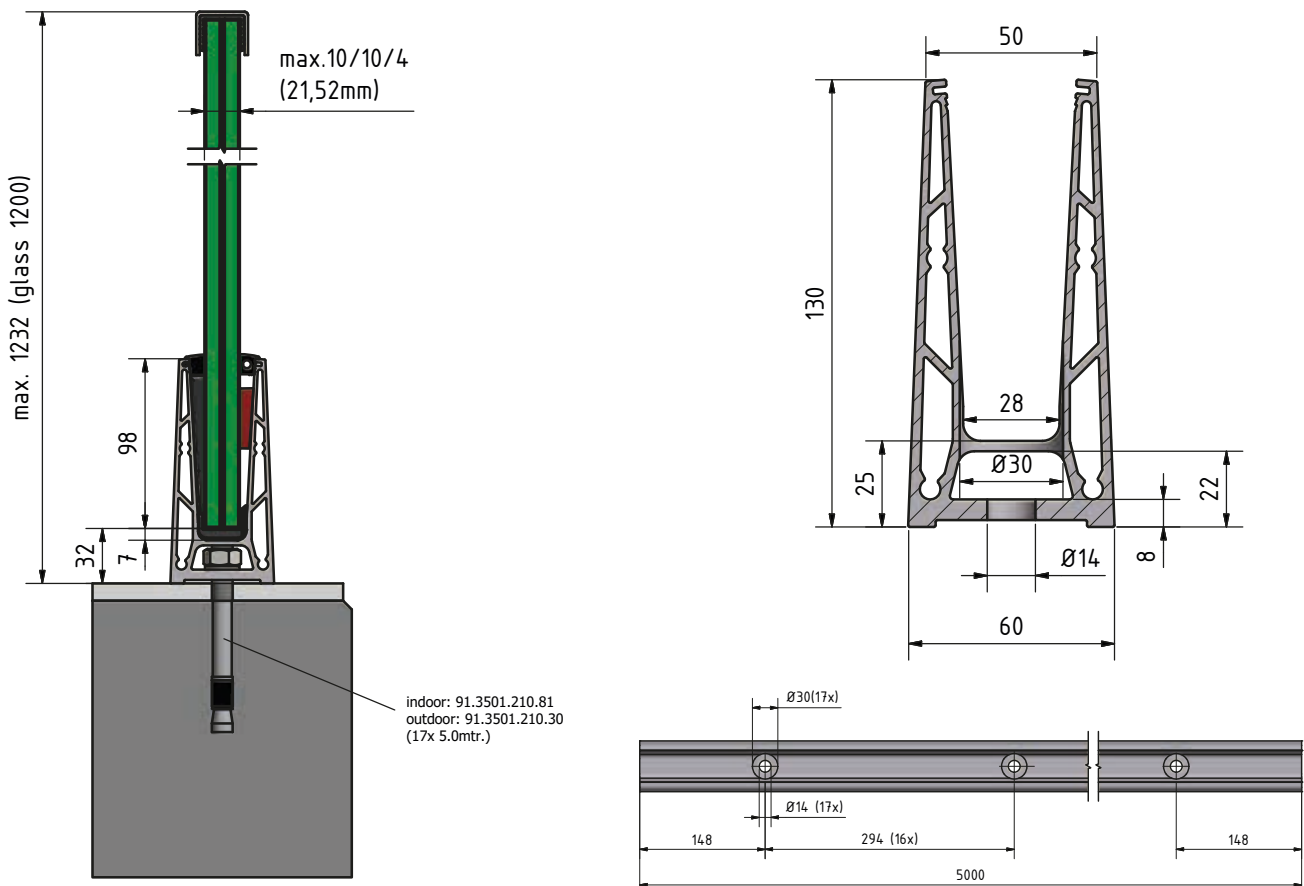



Hollow profile, therefore more lightweight and more economic

Top Cover and Floor Connect



Flat anchors can be used

 Top mount

# TL-6000 | 0.5 kN TOP MOUNT

## Glass profile



| Height: 130 mm  
| Width: 60 mm  
| Sales unit: 1 piece

Model 6000	Mill finish	Plain aluminium	RAL coloured
Length	Art. no.	Art. no.	Art. no.
2500	-	10.6000.002.11	-
5000	10.6000.005.10	10.6000.005.11	10.6000.005.13/16/18

## Inside corner / outside corner 90°



| Side length inside 140 mm  
| Side length outside 200 mm  
| Sales unit: 1 piece

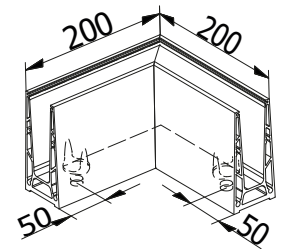

Model 6000	Mill finish	Plain aluminium	RAL coloured
	Art. no.	Art. no.	Art. no.
	10.6000.390.10	10.6000.390.11	10.6000.390.13/16/18

## End cap, left/right



| For use on the left and right  
| Sales unit: 1 piece

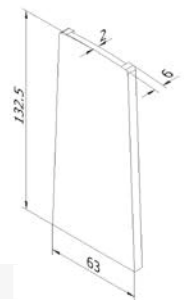

Model 6000	Mill finish	Plain aluminium	RAL coloured
Application	Art. no.	Art. no.	Art. no.
left/right	10.6000.490.10	10.6000.490.11	10.6000.490.13/16/18

## Spacer



You do not have any drainage options on your balcony?!  
So that you do not need to install a dam on your balcony, you can simply mount the spacers beneath your profile.

| Inner drill hole: Ø 14 mm  
| Sales unit: 13 pieces

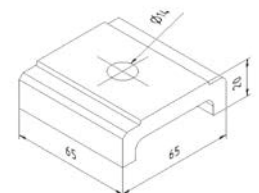

Model 6000	Mill finish	Plain aluminium	RAL coloured
	Art. no.	Art. no.	Art. no.
	10.6000.500.10	10.6000.500.11	10.6000.500.13/16/18

# TL-6000 | 0.5 kN TOP MOUNT

## Fischer fixing anchor FAZ II 12/10



- | Finish interior application: zinc-plated steel (interior)
- | Finish exterior application: V4A (exterior)
- | Required number per 5000 mm: 17 pieces
- | M12
- | Sales unit: 20 pieces

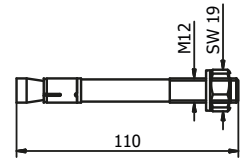

Model 3501	Zinc-plated steel (interior)	AISI 316 (exterior)
Art. no.		Art. no.
	91.3501.210.81	91.3501.210.30

## Extension pin



- | Length: 40 mm
- | Diameter: Ø 6 mm
- | Sales unit: 8 piece

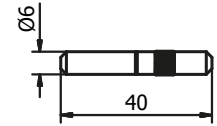

Model 7001	AISI 316 (inside & outside)
Art. no.	
	90.7001.640.31

## Fixing anchor steel



- | Finish interior application: zinc-plated steel (inside)
- | Finish exterior application: V4A (exterior)
- | Required number per 2500 mm: 13 pieces
- | M10 x 60 mm
- | Sales unit: 25 pieces

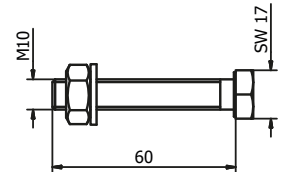

Model 6020	zinc-plated steel (inside)	AISI 316 (exterior)
Art. no.		Art. no.
	91.6020.060.81	91.6020.060.30

## Screw anchor for concrete



- | Suitable for our profiles without countersinking
- | Finish interior application: Zinc-plated steel (interior) HUS3-H 10x90
- | Finish exterior application: V4A (outside) HUS3-HR 10x95
- | Tangential screwdriver required

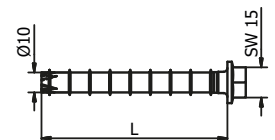

Model 3701	zinc-plated steel (inside)	Model 3701	AISI 316 (exterior)
Sales unit	Art. no.	Sales unit	Art. no.
50	91.3701.090.81	25	91.3701.095.30

# TL-6000 | 0.5 kN TOP MOUNT

## FLEXFIT 1.0 kN



- | Fine adjustment of glass panes
- | For glass thicknesses between 12 - 21.52 mm
- | Adjustment of up to 34 mm in relation to the vertical axis
- | Pay attention to the right glass thickness!

Length		2500 mm	5000 mm	25 mtr
Glass thickness	Wedge colour	Art. no.	Art. no.	Art. no.
12 mm	black	90.0502.112.00	90.0505.112.00	90.0525.112.00
6/6/2 (12.76 mm)	red	90.0502.113.00	90.0505.113.00	90.0525.113.00
6/6/4 (13.52 mm)	grey	90.0502.114.00	90.0505.114.00	90.0525.114.00
15 mm	yellow	90.0502.115.00	90.0505.115.00	90.0525.115.00
<b>8/8/2 (16.76 mm)</b>	red	90.0502.117.00	90.0505.117.00	90.0525.117.00
<b>8/8/4 (17.52 mm)</b>	green	90.0502.118.00	90.0505.118.00	90.0525.118.00
19 mm	blue	90.0502.119.00	90.0505.119.00	90.0525.119.00
<b>10/10/2 (20.76 mm)</b>	red	90.0502.121.00	90.0505.121.00	90.0525.121.00
<b>10/10/4 (21.52 mm)</b>	green	90.0502.122.00	90.0505.122.00	90.0525.122.00

# SEALING OF BALUSTRADE SYSTEMS

**Attention, this is the OnLevel Water Police speaking. Your building is leaking!**

This is exactly the challenge we are facing. There are manufacturers who really believe that this issue can be solved with a base profile. Never ever, my friends. We have counted exactly 987,339 different applications. That is why we need to be as flexible as possible to be ready to adapt to the most diverse conditions. This is where the modular principle comes into play. Please see in the following figure what our drainage holes look like and which path the water takes.

Here, we need a proper seal.

And of course, we have some possible solutions for you.



# TL-6010

1.0 kN Top Mount

## The Mother of Profiles.

The TL-6010 U-profile is not only cost-effective. It is actually the mother of all profiles, or even better: It is the hidden pearl among profiles. The TL-6010 U-profile is completely invisible and in combination with a structural connection profile, its application versatility increases considerably.

As a matter of fact, the profile is suited both for interior and exterior applications. It can withstand a linear load of more 1.0 kN and is appropriate for glass thicknesses between 12 mm and 21.52 mm.

## Essential Features

- | Slimline, elegant design and low-maintenance
- | ONLEVEL FLEXFIT Glass Adjustment Tool
- | Top Cover (optional)
- | For glass thicknesses between 12 - 21.52 mm



TESTED  
according to  
**BS6180**

CE EN1090-1  
EN1090-3  
EXC 3

riba  
product  
selector

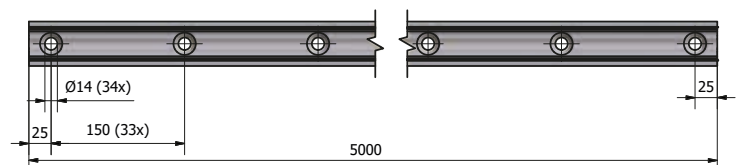
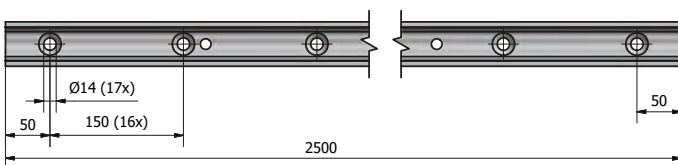
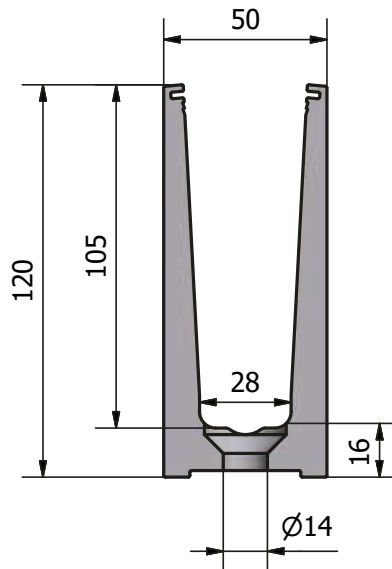
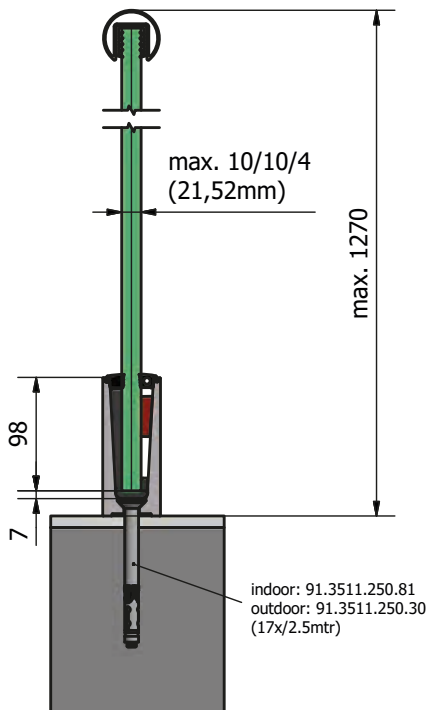





Unlimited application  
versatility

Ideal for concealed  
installation

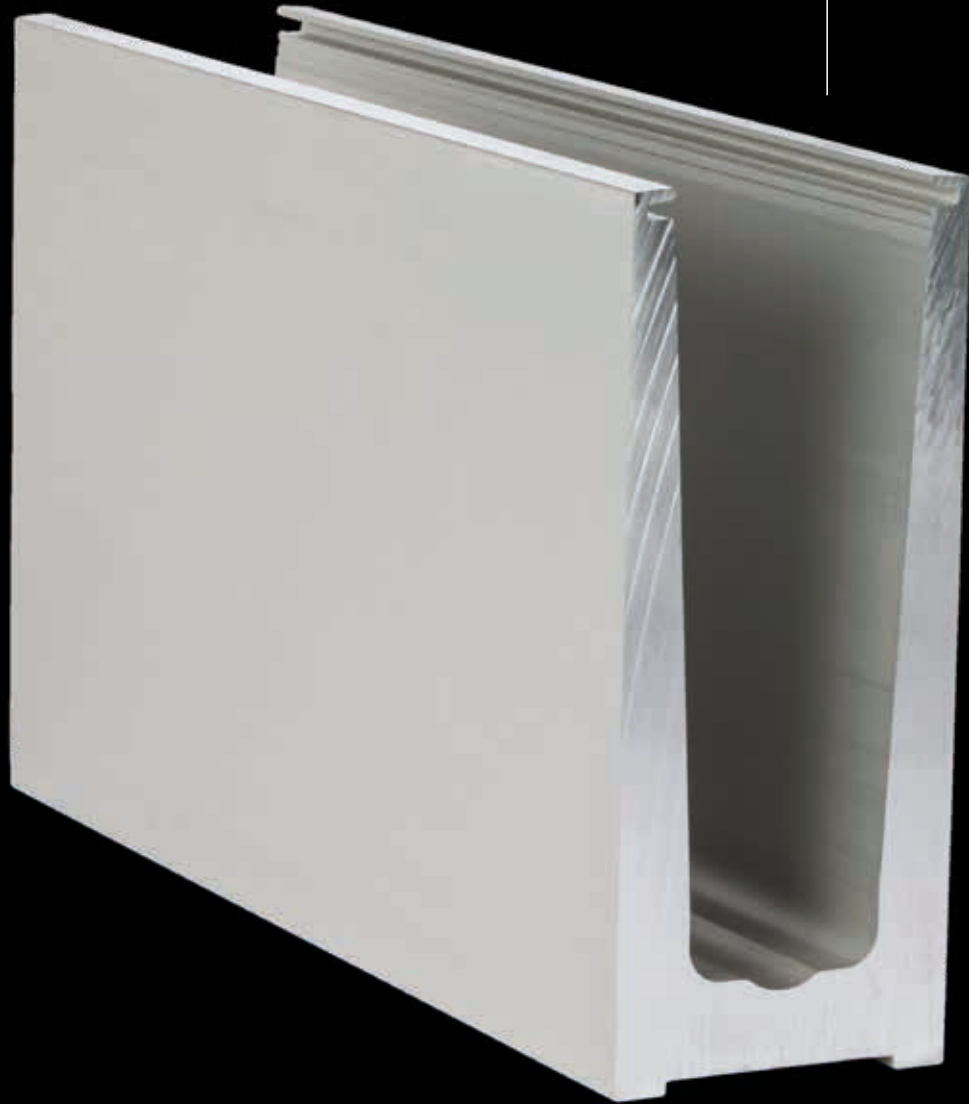

Top mount



# TL-6010 | 1.0 KN TOP MOUNT

## Glass profile



| Height: 120 mm  
| Width: 50 mm  
| Sales unit: 1 piece

Model 6010	Mill finish	Plain aluminium	RAL coloured
Length	Art. no.	Art. no.	Art. no.
2500	-	10.6010.002.11	-
5000	10.6010.005.10	10.6010.005.11	10.6010.005.13/16/18

## Inside corner / outside corner 90°



| Side length inside: 150 mm  
| Side length outside: 200 mm  
| Sales unit: 1 piece

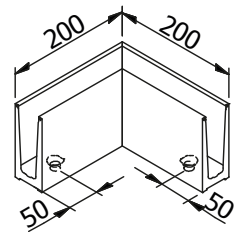

Model 6010	Mill finish	Plain aluminium	RAL coloured
	Art. no.	Art. no.	Art. no.
	10.6010.390.10	10.6010.390.11	10.6010.390.13/16/18

## End cap, left/right



| For use on the left and right  
| Sales unit: 1 piece

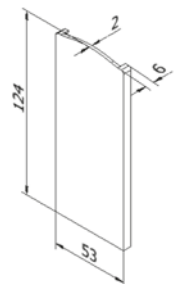

Model 6010	Mill finish	Plain aluminium	RAL coloured
Application	Art. no.	Art. no.	Art. no.
left/right	10.6010.490.10	10.6010.490.11	10.6010.490.13/16/18

## End cap for staircase, left/right



| For use on the left and right  
| can be cut to size  
| Sales unit: 1 piece

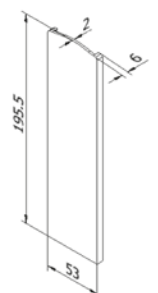

Model 6010	Mill finish	Plain aluminium	RAL coloured
Application	Art. no.	Art. no.	Art. no.
left/right	10.6010.491.10	10.6010.491.11	10.6010.491.13/16/18

# TL-6010 | 1.0 KN TOP MOUNT

## Spacer



You do not have any drainage options on your balcony?!  
So that you do not need to install a dam on your balcony, you can simply mount the spacers beneath your profile.

- | Inner drill hole:  $\varnothing$  14 mm
- | Sales unit: 17 pieces

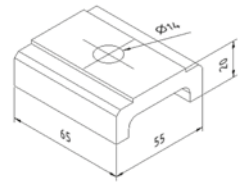

Model 6010	Mill finish	Plain aluminium	RAL coloured
	Art. no.	Art. no.	Art. no.
	10.6010.500.10	10.6010.500.11	10.6010.500.13/16/18

## Fischer fixing anchor FH II 12/50 SK



- | Finish interior application: zinc-plated steel (inside)
- | Finish exterior application: V4A (exterior)
- | Required number per 2500 mm: 17 pieces
- | Sales unit: 25 pieces

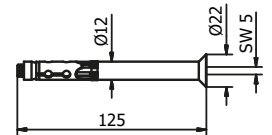

Model 3511	zinc-plated steel (inside)	AISI 316 (exterior)
Length	Art. no.	Art. no.
125	91.3511.250.81	91.3511.250.30

## Fixing anchor steel



- | Finish interior application: zinc-plated steel (inside)
- | Finish exterior application: V4A (exterior)
- | Required number per 2500 mm: 17 pieces
- | M10 x 40 mm
- | Sales unit: 17 pieces

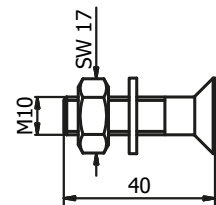

Model 6010	zinc-plated steel (inside)	AISI 316 (exterior)
	Art. no.	Art. no.
	91.6010.040.81	91.6010.040.30

# TL-6010 | 1.0 KN TOP MOUNT

## FLEXFIT 1.0 KN



- | Fine adjustment of glass panes
- | For glass thicknesses between 12 - 21.52 mm
- | Adjustment of up to 34 mm in relation to the vertical axis
- | Pay attention to the right glass thickness!

Length		2500 mm	5000 mm	25 mtr
Glass thickness	Wedge colour	Art. no.	Art. no.	Art. no.
12 mm	black	90.0502.112.00	90.0505.112.00	90.0525.112.00
6/6/2 (12.76 mm)	red	90.0502.113.00	90.0505.113.00	90.0525.113.00
6/6/4 (13.52 mm)	grey	90.0502.114.00	90.0505.114.00	90.0525.114.00
15 mm	yellow	90.0502.115.00	90.0505.115.00	90.0525.115.00
<b>8/8/2 (16.76 mm)</b>	red	90.0502.117.00	90.0505.117.00	90.0525.117.00
<b>8/8/4 (17.52 mm)</b>	green	90.0502.118.00	90.0505.118.00	90.0525.118.00
19 mm	blue	90.0502.119.00	90.0505.119.00	90.0525.119.00
<b>10/10/2 (20.76 mm)</b>	red	90.0502.121.00	90.0505.121.00	90.0525.121.00
<b>10/10/4 (21.52 mm)</b>	green	90.0502.122.00	90.0505.122.00	90.0525.122.00

# ONE SIZE. ONE LEVEL.

Our end caps for staircases can be easily adjusted to the desired dimension. The lines on the rear of the end cap facilitate cutting it to shape and adjusting it to any desired angle.

Cut to Size



# TL-6011

1.0 kN Side Mount

## Simply Minimal.

The TL-6011 U-profile is the intelligent solution for simple installations without screed onto steel or concrete. The profile can be used both in interior and exterior applications, withstands a linear load of 1.0 kN and is suitable for glass thicknesses between 12 mm and 21.52 mm.

## Essential Features

- | Slimline, elegant design and low-maintenance
- | ONLEVEL FLEXFIT Glass Adjustment Tool
- | Extension pin holes
- | Drainage holes
- | Top Cover (optional)
- | Cover cap (optional)
- | Integrated multifunctional sophisticated chamber
- | For glass thicknesses between 12 - 21.52 mm



TESTED  
according to  
BS6180

CE EN1090-1  
EN1090-3  
EXC 3

riba  
product  
selector

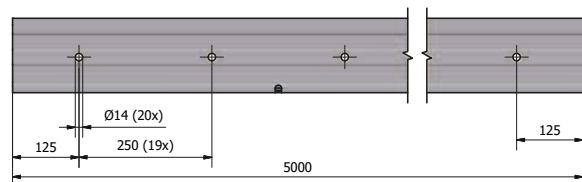
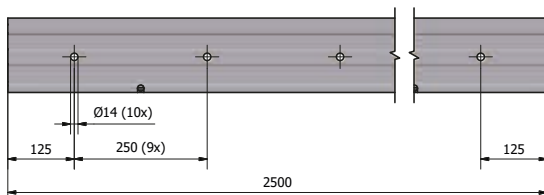
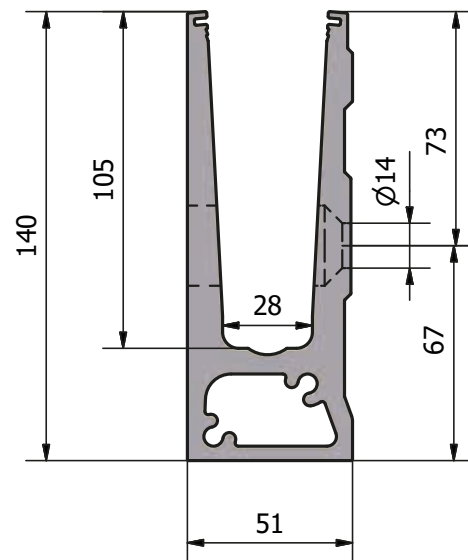
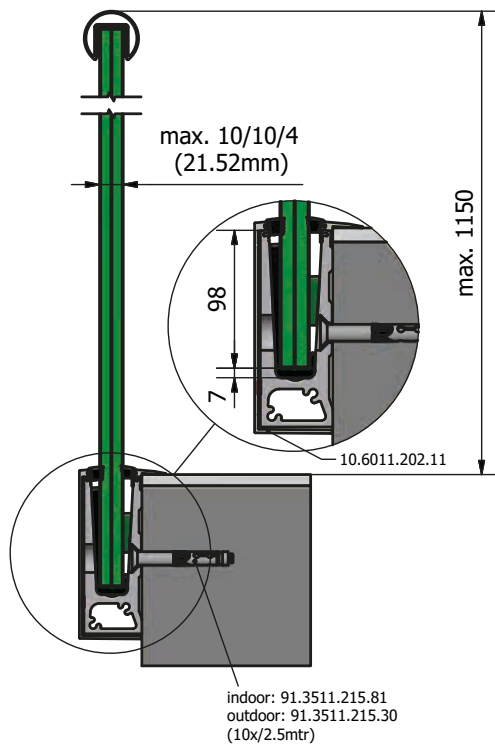



For simple installation without  
screed onto steel or concrete



Side mount

Integrated multifunctional  
sophisticated chamber for  
enabling larger drilling distances

# TL-6011 | 1.0 KN SIDE MOUNT

## Glass profile



| Height: 140 mm  
| Width 51 mm  
| Sales unit: 1 piece

Model 6011	Mill finish	Plain aluminium	RAL coloured
Length	Art. no.	Art. no.	Art. no.
2500	-	10.6011.002.11	-
5000	10.6011.005.10	10.6011.005.11	10.6011.005.13/16/18

## Inside corner 90°



| Side length inside: 149 mm  
| Side length outside: 200 mm  
| Sales unit: 1 piece

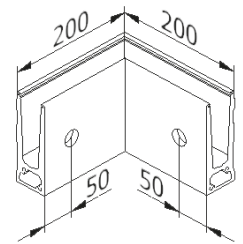

Model 6011	Mill finish	Plain aluminium	RAL coloured
	Art. no.	Art. no.	Art. no.
	10.6011.300.10	10.6011.300.11	10.6011.300.13/16/18

## Outside corner 90°



| Side length inside: 149 mm  
| Side length outside: 200 mm  
| Sales unit: 1 piece

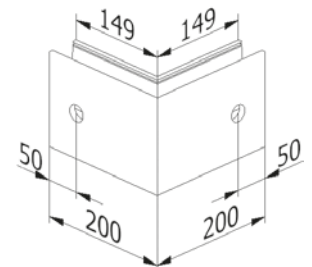

Model 6011	Mill finish	Plain aluminium	RAL coloured
	Art. no.	Art. no.	Art. no.
	10.6011.350.10	10.6011.350.11	10.6011.350.13/16/18

## Cover strip



| With mounting strips  
| For use with a cover cap, end caps must be ordered separately.  
| Sales unit: 1 piece

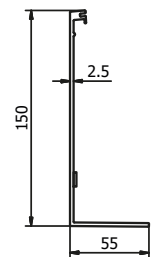

Model 6011	Mill finish	Plain aluminium	RAL coloured
Length	Art. no.	Art. no.	Art. no.
2500	-	10.6011.202.11	-
5000	10.6011.205.10	10.6011.205.11	10.6011.205.13/16/18



# TL-6011 | 1.0 KN SIDE MOUNT

## Blanking plug



| Required number per 2500 mm: 10 pieces  
| Sales unit: 10 pieces

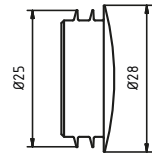

Model 7000		Plastic
Colour	Diameter	Art. no.
white	25 mm	90.7000.025.40
black	25 mm	90.7000.025.41
grey	25 mm	90.7000.025.45

## End cap without cover strip, left



| For use on the left  
| Sales unit: 1 piece

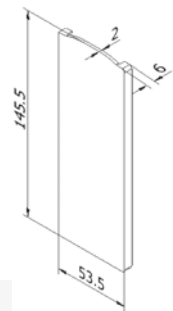

Model 6011	Mill finish	Plain aluminium	RAL coloured
Application	Art. no.	Art. no.	Art. no.
left	10.6011.400.10	10.6011.400.11	10.6011.400.13/16/18

## End cap without cover strip, right



| For use on the right  
| Sales unit: 1 piece



Model 6011	Mill finish	Plain aluminium	RAL coloured
Application	Art. no.	Art. no.	Art. no.
right	10.6011.450.10	10.6011.450.11	10.6011.450.13/16/18

## End cap without cover strip, left staircase



| For use on the left  
| can be cut to size  
| Sales unit: 1 piece

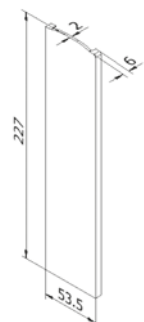

Model 6011	Mill finish	Plain aluminium	RAL coloured
Application	Art. no.	Art. no.	Art. no.
left	10.6011.401.10	10.6011.401.11	10.6011.401.13/16/18

# TL-6011 | 1.0 KN SIDE MOUNT

## End cap without cover strip, right staircase



| For use on the right  
| can be cut to size  
| Sales unit: 1 piece



Model 6011	Mill finish	Plain aluminium	RAL coloured
Application	Art. no.	Art. no.	Art. no.
right	10.6011.451.10	10.6011.451.11	10.6011.451.13/16/18

## End cap with cover strip, left



| For use on the left  
| Sales unit: 1 piece

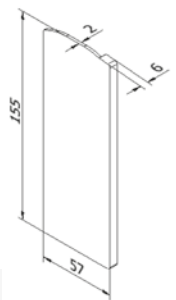

Model 6011	Mill finish	Plain aluminium	RAL coloured
Application	Art. no.	Art. no.	Art. no.
left	10.6011.410.10	10.6011.410.11	10.6011.410.13/16/18

## End cap with cover strip, right



| For use on the right  
| Sales unit: 1 piece

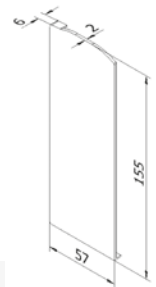

Model 6011	Mill finish	Plain aluminium	RAL coloured
Application	Art. no.	Art. no.	Art. no.
right	10.6011.460.10	10.6011.460.11	10.6011.460.13/16/18

## End cap for staircase with cover strip, left



| For use on the left  
| can be cut to size  
| Sales unit: 1 piece

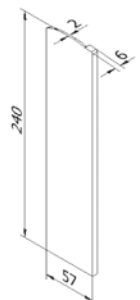

Model 6011	Mill finish	Plain aluminium	RAL coloured
Application	Art. no.	Art. no.	Art. no.
left	10.6011.411.10	10.6011.411.11	10.6011.411.13/16/18

# TL-6011 | 1.0 KN SIDE MOUNT

## End cap for staircase with cover strip, right



- | For use on the right
- | can be cut to size
- | Sales unit: 1 piece



Model 6011	Mill finish	Plain aluminium	RAL coloured
Application	Art. no.	Art. no.	Art. no.
right	10.6011.461.10	10.6011.461.11	10.6011.461.13/16/18

## Spacer



You do not have any drainage options on your balcony?!  
So that you do not need to install a dam on your balcony, you can simply mount the spacers behind your profile.

- | Required number per 2500 mm: 10 pieces
- | Inner drill hole: Ø 14 mm
- | Sales unit: 10 pieces

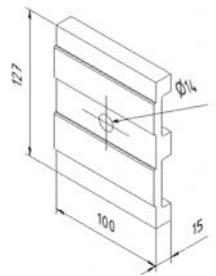

Model 6011	Mill finish	Plain aluminium	RAL coloured
	Art. no.	Art. no.	Art. no.
	10.6011.500.10	10.6011.500.11	10.6011.500.13/16/18

## Extension pin



- | Length: 40 mm
- | Diameter: Ø 6 mm
- | Sales unit: 8 pieces

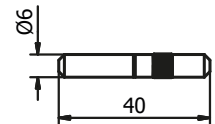

Model 7001	AISI 316 (inside & outside)
	Art. no.
	90.7001.640.31

## Fischer fixing anchor FH II 12/15 SK



- | Finish interior application: zinc-plated steel (inside)
- | Finish exterior application: V4A (exterior)
- | Required number per 2500 mm: 10 pieces
- | Sales unit: 25 pieces

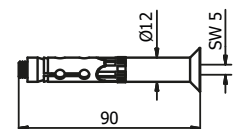

Model 3511	zinc-plated steel (inside)	AISI 316 (exterior)
	Art. no.	Art. no.
	91.3511.215.81	91.3511.215.30

# TL-6011 | 1.0 KN SIDE MOUNT

## Fixing anchor steel



- | Finish interior application: zinc-plated steel (inside)
- | Finish exterior application: V4A (exterior)
- | Required number per 2500 mm: 10 pieces
- | M10 x 40 mm
- | Sales unit: 10 pieces

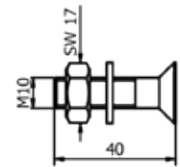

Model 6011	zinc-plated steel (inside)	AISI 316 (exterior)
	Art. no.	Art. no.
	91.6011.040.81	91.6011.040.30

## Mounting set for wood



- | Finish interior application: zinc-plated steel (inside)
- | Required number per 2500 mm: 10 pieces
- | M12
- | Sales unit: 10 pieces

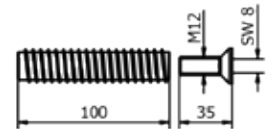

Model 6011	zinc-plated steel (inside)
	Art. no.
	91.6011.800.81



## FLEXFIT 1.0 kN



- | Fine adjustment of glass panes
- | For glass thicknesses between 12 - 21.52 mm
- | Adjustment of up to 34 mm in relation to the vertical axis
- | Pay attention to the right glass thickness!

Length		2500 mm	5000 mm	25 mtr
Glass thickness	Wedge colour	Art. no.	Art. no.	Art. no.
12 mm	black	90.0502.112.00	90.0505.112.00	90.0525.112.00
6/6/2 (12.76 mm)	red	90.0502.113.00	90.0505.113.00	90.0525.113.00
6/6/4 (13.52 mm)	grey	90.0502.114.00	90.0505.114.00	90.0525.114.00
15 mm	yellow	90.0502.115.00	90.0505.115.00	90.0525.115.00
<b>8/8/2 (16.76 mm)</b>	red	90.0502.117.00	90.0505.117.00	90.0525.117.00
<b>8/8/4 (17.52 mm)</b>	green	90.0502.118.00	90.0505.118.00	90.0525.118.00
19 mm	blue	90.0502.119.00	90.0505.119.00	90.0525.119.00
<b>10/10/2 (20.76 mm)</b>	red	90.0502.121.00	90.0505.121.00	90.0525.121.00
<b>10/10/4 (21.52 mm)</b>	green	90.0502.122.00	90.0505.122.00	90.0525.122.00

# LARGER MOUNTING DISTANCES.

## **Mounting and Innovating.**

They are written with capital letters and form part of our philosophy: We look at the product as a whole. Apart from safety and a classical, timeless design, ONLEVEL attaches special importance to assembly costs. We have achieved a continuous reduction of the number of anchors required for a glass support profile. Nevertheless, we have never lost sight of the necessary stability. Each anchor which is no longer required, does not need to be bought and thus saves you a drill hole, and the associated. We have developed an integrated **multifunctional sophisticated chamber** instead which combines exactly these features.

Pay attention to the logo indicating the suitable application types.



# TL-6020

1.0 kN Top Mount

## Level Up.

The TL-6020 U-profile is the intelligent onward development of the TL-6010 profile. Here the outstanding feature consists in the increase of mounting distances, which now enables the use of the profile also on an anchor bolt without countersunk head. Therefore, mounting the product is not only faster and more cost efficient, but also statics have improved considerably.

It can be used in exterior applications, withstands a linear load of 1.0 kN and is appropriate for glass thicknesses between 12 mm and 21.52 mm.

## Essential Features

- | Slimline, elegant design and low-maintenance
- | ONLEVEL FLEXFIT Glass Adjustment Tool
- | Extension pin holes
- | Drainage holes
- | For use with Top Cover 3.0 kN
- | For glass thicknesses between 12 - 21.52 mm
- | For applications of 1.0 kN in private areas, the mounting distance amounts to 60 cm



**TESTED**  
according to  
**BS6180**

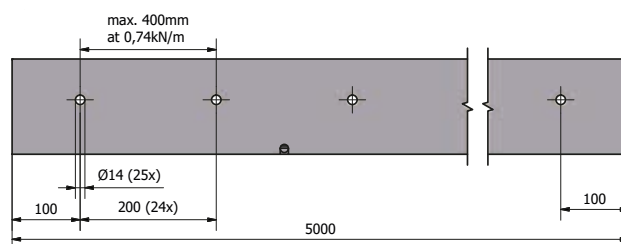
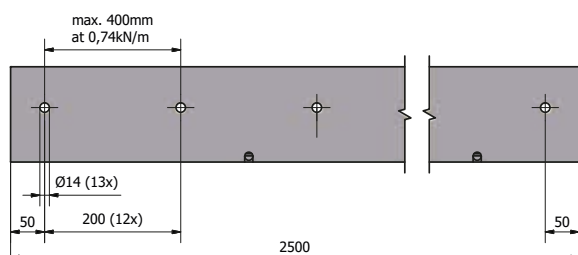
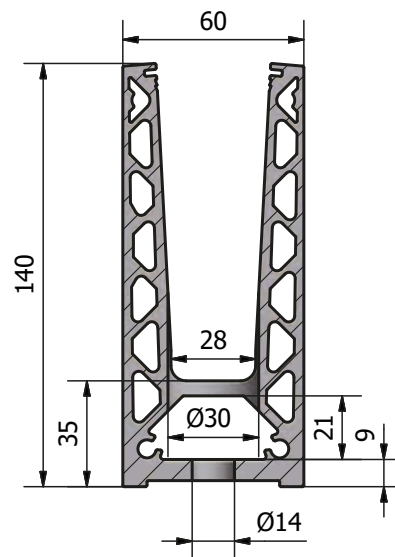
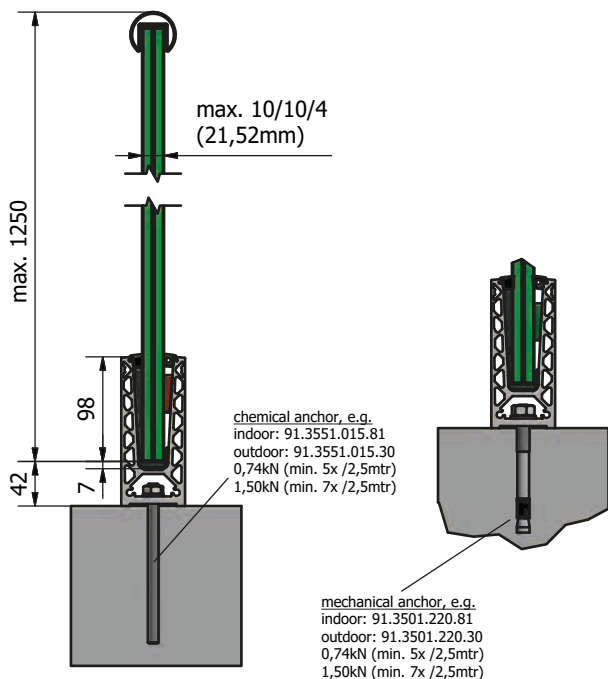

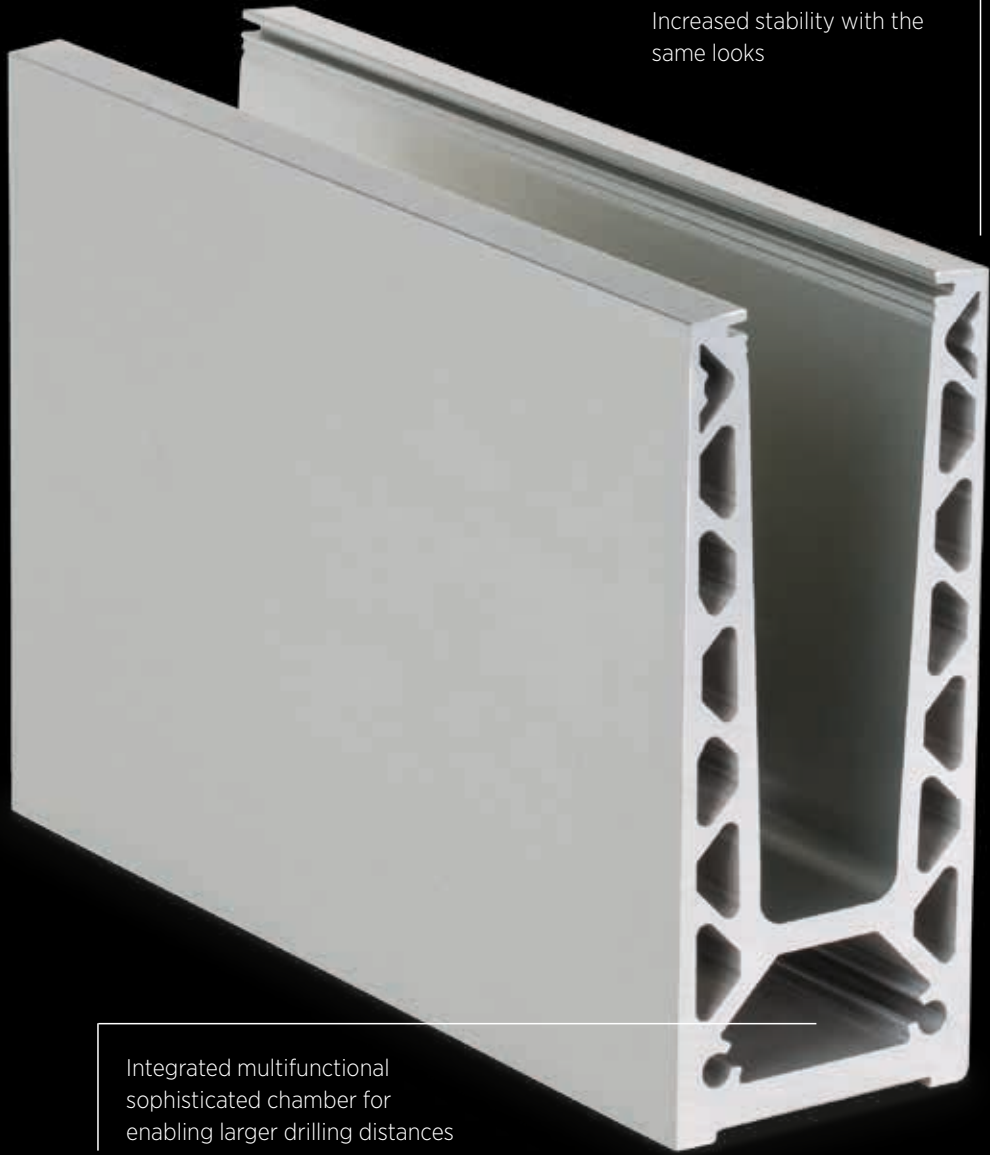

Increased stability with the same looks

Integrated multifunctional sophisticated chamber for enabling larger drilling distances



Top mount

# TL-6020 | 1.0 KN TOP MOUNT

## Glass profile



| Height: 140 mm  
| Width: 60 mm  
| Sales unit: 1 piece

Model 6020	Mill finish	Plain aluminium	RAL coloured
Length	Art. no.	Art. no.	Art. no.
2500	-	10.6020.002.11	-
5000	10.6020.005.10	10.6020.005.11	10.6020.005.13/16/18

## Inside corner / outside corner 90°



| Side length inside: 140 mm  
| Side length outside: 200 mm  
| Sales unit: 1 piece

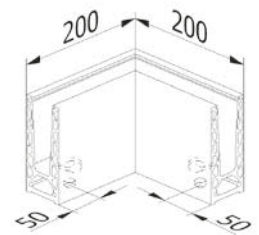

Model 6020	Mill finish	Plain aluminium	RAL coloured
	Art. no.	Art. no.	Art. no.
	10.6020.390.10	10.6020.390.11	10.6020.390.13/16/18

## End cap, left/right



| For use on the left and right  
| Sales unit: 1 piece

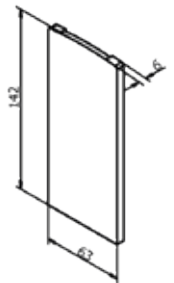

Model 6020	Mill finish	Plain aluminium	RAL coloured
Application	Art. no.	Art. no.	Art. no.
left/right	10.6020.490.10	10.6020.490.11	10.6020.490.13/16/18

## End cap for staircase, left/right



| For use on the left and right  
| cut-to-size  
| Sales unit: 1 piece

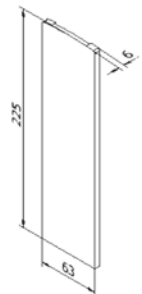

Model 6020	Mill finish	Plain aluminium	RAL coloured
Application	Art. no.	Art. no.	Art. no.
left/right	10.6020.491.10	10.6020.491.11	10.6020.491.13/16/18



# TL-6020 | 1.0 KN TOP MOUNT

## Spacer



You do not have any drainage options on your balcony?!  
So that you do not need to install a dam on your balcony, you can simply mount the spacers beneath your profile.

- | Inner drill hole:  $\varnothing$  14 mm
- | Sales unit: 13 pieces

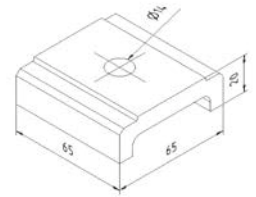

Model 6020	Mill finish	Plain aluminium	RAL coloured
	Art. no.	Art. no.	Art. no.
	10.6020.500.10	10.6020.500.11	10.6020.500.13/16/18

## Extension pin



- | Length: 40 mm
- | Diameter:  $\varnothing$  6 mm
- | Sales unit: 8 piece

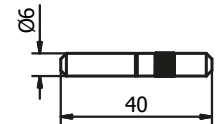

Model 7001	AISI 316 (inside & outside)
	Art. no.
	90.7001.640.31

## Fischer fixing anchor FIS AM M10x150



- | Finish interior application: zinc-plated steel (inside)
- | Finish exterior application: V4A (exterior)
- | Required number per 2500 mm: 13 pieces
- | Suitable mortar: 91.3000.010.00
- | Injection mortar (91.3000.010.00) is sufficient for  $\pm$  26 anchors
- | Sales unit: 10 pieces

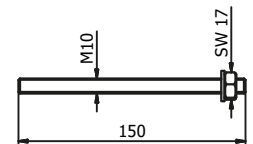

Model 3551	zinc-plated steel (inside)	AISI 316 (exterior)
	Art. no.	Art. no.
	91.3551.015.81	91.3551.015.30

## Fixing anchor steel



- | Finish interior application: zinc-plated steel (inside)
- | Finish exterior application: V4A (exterior)
- | Required number per 2500 mm: 13 pieces
- | M10 x 60 mm
- | Sales unit: 25 pieces

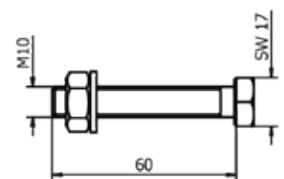

Model 6020	zinc-plated steel (inside)	AISI 316 (exterior)
	Art. no.	Art. no.
	91.6020.060.81	91.6020.060.30

# TL-6020 | 1.0 KN TOP MOUNT

## Fischer fixing anchor FAZ II 12/10



- | Finish interior application: zinc-plated steel (inside)
- | Finish exterior application: V4A (exterior)
- | Required number per 2500 mm: 7 pieces
- | Sales unit: 20 pieces

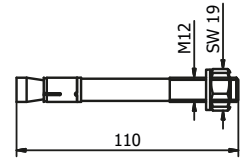

Model 3501	zinc-plated steel (inside)	AISI 316 (exterior)
	Art. no.	Art. no.
	91.3501.210.30	91.3501.210.81

## Screw anchor for concrete



- | Suitable for our profiles without countersinking
- | Finish interior application: Zinc-plated steel (interior) HUS3-H 10x90
- | Finish exterior application: V4A (outside) HUS3-HR 10x95
- | Tangential screwdriver required

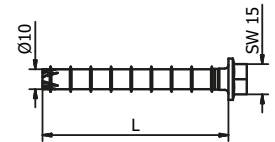

Model 3701	zinc-plated steel (inside)	Model 3701	AISI 316 (exterior)
Sales unit	Art. no.	Sales unit	Art. no.
50	91.3701.090.81	25	91.3701.095.30

## FLEXFIT 1.0 kN



- | Fine adjustment of glass panes
- | For glass thicknesses between 12 - 21.52 mm
- | Adjustment of up to 34 mm in relation to the vertical axis
- | Pay attention to the right glass thickness!

Length		2500 mm	5000 mm	25 mtr
Glass thickness	Wedge colour	Art. no.	Art. no.	Art. no.
12 mm	black	90.0502.112.00	90.0505.112.00	90.0525.112.00
6/6/2 (12.76 mm)	red	90.0502.113.00	90.0505.113.00	90.0525.113.00
6/6/4 (13.52 mm)	grey	90.0502.114.00	90.0505.114.00	90.0525.114.00
15 mm	yellow	90.0502.115.00	90.0505.115.00	90.0525.115.00
<b>8/8/2 (16.76 mm)</b>	red	90.0502.117.00	90.0505.117.00	90.0525.117.00
<b>8/8/4 (17.52 mm)</b>	green	90.0502.118.00	90.0505.118.00	90.0525.118.00
19 mm	blue	90.0502.119.00	90.0505.119.00	90.0525.119.00
<b>10/10/2 (20.76 mm)</b>	red	90.0502.121.00	90.0505.121.00	90.0525.121.00
<b>10/10/4 (21.52 mm)</b>	green	90.0502.122.00	90.0505.122.00	90.0525.122.00

# TAKE A LITTLE DISTANCE – WITH OUR SPACER.

Hoover Dam is a thing of the past. There is more water on balconies than in the legendary dammed Colorado River. We have the suitable spacer for every profile to keep your feet dry. In addition, our spacers are constructed such as to adapt themselves to all static conditions.

---

10.xxxx.500.xx

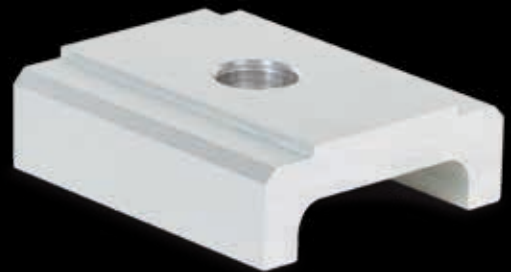

# TL-6021

1.0 kN Side Mount

## The Evolution Goes On.

The TL-6021 U-profile is the intelligent onward development of the TL-6011 profile. Here the outstanding feature consists in the increase of mounting distances, which now enables the use of the profile also on an anchor bolt without countersunk head. This makes mounting the product not only much quicker and more cost efficient, also statics have improved significantly.

The TL-6021 U-profile can be used for exterior applications. It can withstand a linear load of 1.0 kN and is appropriate for glass thicknesses between 12 mm and 21.52 mm.

## Essential Features

- | Slimline, elegant design and low-maintenance
- | ONLEVEL FLEXFIT Glass Adjustment Tool
- | Drainage holes
- | Cover (optional)
- | For use with Top Cover 3.0 kN
- | For glass thicknesses between 12 mm and 21.52 mm
- | For applications of 0.10kN in private areas, the mounting distance amounts to 40 cm

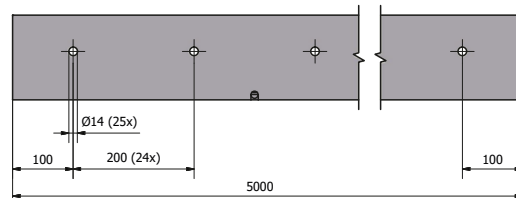
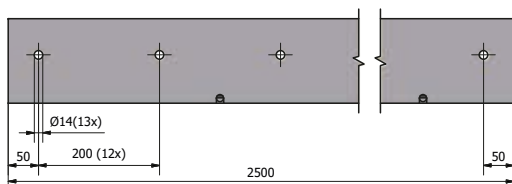
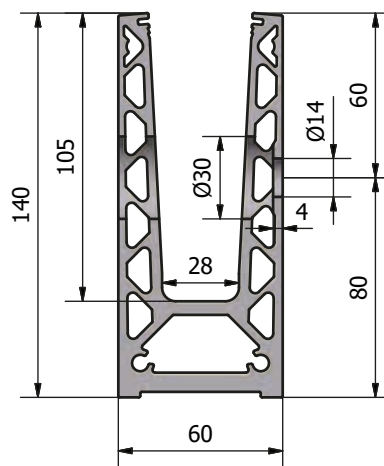
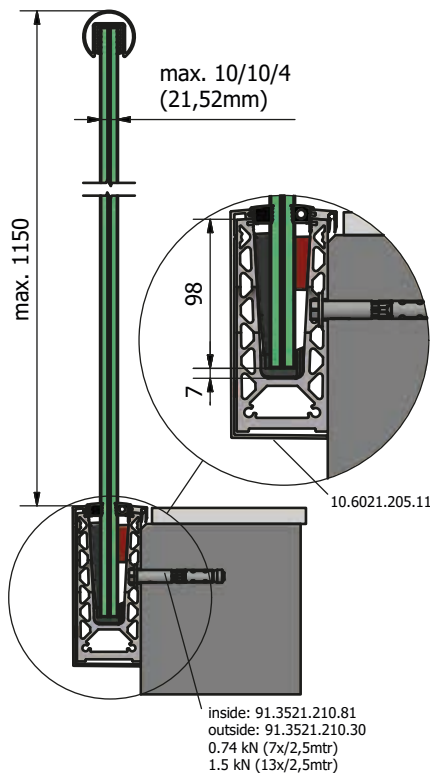



Improved statics

Can be anchored universally depending on the application



Side mount

Integrated multifunctional sophisticated chamber for enabling larger drilling distances

# TL-6021 | 1.0 KN SIDE MOUNT

## Glass profile



| Height: 140 mm  
| Width: 60 mm  
| Sales unit: 1 piece

Model 6021	Mill finish	Plain aluminium	RAL coloured
Length	Art. no.	Art. no.	Art. no.
2500	-	10.6021.002.11	-
5000	10.6021.005.10	10.6021.005.11	10.6021.005.13/16/18

## Inside corner 90°



| Side length inside: 140 mm  
| Side length outside: 200 mm  
| Sales unit: 1 piece

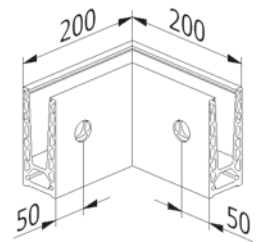

Model 6021	Mill finish	Plain aluminium	RAL coloured
	Art. no.	Art. no.	Art. no.
	10.6021.300.10	10.6021.300.11	10.6021.300.13/16/18

## Outside corner 90°



| Side length inside: 140 mm  
| Side length outside: 200 mm  
| Sales unit: 1 piece

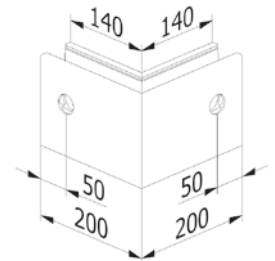

Model 6021	Mill finish	Plain aluminium	RAL coloured
	Art. no.	Art. no.	Art. no.
	10.6021.350.10	10.6021.350.11	10.6021.350.13/16/18

## End cap, left



| For use on the left  
| Sales unit: 1 piece

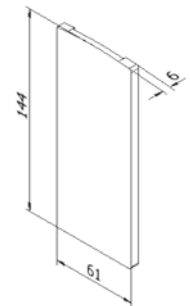

Model 6021	Mill finish	Plain aluminium	RAL coloured
Application	Art. no.	Art. no.	Art. no.
left	10.6021.400.10	10.6021.400.11	10.6021.400.13/16/18

# TL-6021 | 1.0 KN SIDE MOUNT

## End cap, left, with cover cap



| For use on the left  
| Sales unit: 1 piece

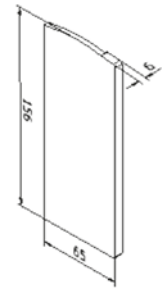

Model 6021	Mill finish	Plain aluminium	RAL coloured
Application	Art. no.	Art. no.	Art. no.
left	10.6021.410.10	10.6021.410.11	10.6021.410.13/16/18

## End cap, right



| For use on the right  
| Sales unit: 1 piece

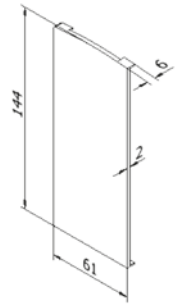

Model 6021	Mill finish	Plain aluminium	RAL coloured
Application	Art. no.	Art. no.	Art. no.
right	10.6021.450.10	10.6021.450.11	10.6021.450.13/16/18

## End cap, right, with cover cap



| For use on the right  
| Sales unit: 1 piece

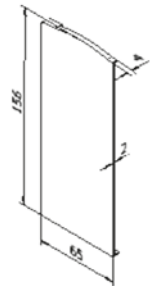

Model 6021	Mill finish	Plain aluminium	RAL coloured
Application	Art. no.	Art. no.	Art. no.
right	10.6021.460.10	10.6021.460.11	10.6021.460.13/16/18

## End cap for staircase with cover strip, left



| For use on the left  
| can be cut to size  
| Sales unit: 1 piece

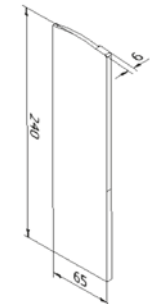

Model 6021	Mill finish	Plain aluminium	RAL coloured
Application	Art. no.	Art. no.	Art. no.
left	10.6021.411.10	10.6021.411.11	10.6021.411.13/16/18

# TL-6021 | 1.0 KN SIDE MOUNT

## End cap for staircase with cover strip, right



| For use on the right  
| can be cut to size  
| Sales unit: 1 piece

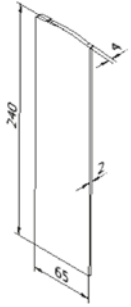

Model 6021	Mill finish	Plain aluminium	RAL coloured
Application	Art. no.	Art. no.	Art. no.
right	10.6021.461.10	10.6021.461.11	10.6021.461.13/16/18

## Cover strip



| With mounting strips  
| For use with a cover cap, end caps must be ordered separately  
| Sales unit: 1 piece

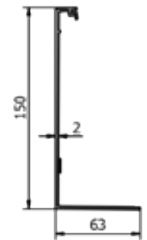

Model 6021	Mill finish	Plain aluminium	RAL coloured
Length	Art. no.	Art. no.	Art. no.
2500	-	10.6021.202.11	-
5000	10.6021.205.10	10.6021.205.11	10.6021.205.13/16/18

## Spacer



| Thickness: 15 mm  
| Sales unit: 13 pieces

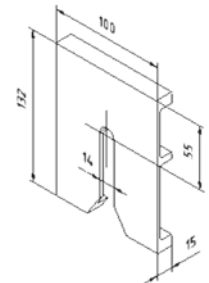

Model 6021	Mill finish	Plain aluminium	RAL coloured
	Art. no.	Art. no.	Art. no.
	10.6021.500.10	10.6021.500.11	10.6021.500.13/16/18

## Blanking plug



| Required number per 2500 mm: 17 pieces  
| Sales unit: 10 pieces

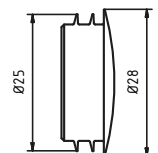

Model 7000	Plastic	
Colour	Diameter	Art. no.
white	30 mm	90.7000.030.40
black	30 mm	90.7000.030.41
grey	30 mm	90.7000.030.45



# TL-6021 | 1.0 KN SIDE MOUNT

## Extension pin



- | Length: 40 mm
- | Diameter: Ø 6 mm
- | Sales unit: 8 piece

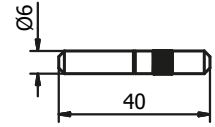

<b>Model 7001</b>	<b>AISI 316 (inside &amp; outside)</b>
-------------------	--

Art. no.
----------

90.7001.640.31
----------------

## Fischer fixing anchor FH II 12/10



- | Finish interior application: zinc-plated steel (inside)
- | Finish exterior application: V4A (exterior)
- | Required number per 2500 mm: 13 pieces
- | Sales unit: 50 pieces

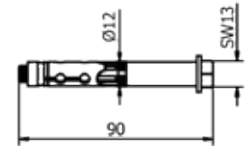

<b>Model 3521</b>	<b>zinc-plated steel (inside)</b>	<b>AISI 316 (exterior)</b>
-------------------	-----------------------------------	----------------------------

Art. no.
----------

91.3521.210.81
----------------

Art. no.
----------

91.3521.210.30
----------------

## Mounting set for steel



- | Finish interior application: zinc-plated steel (inside)
- | Finish exterior application: V4A (exterior)
- | Required number per 2500 mm: 13 pieces
- | M10 x 60 mm
- | Sales unit: 13 pieces

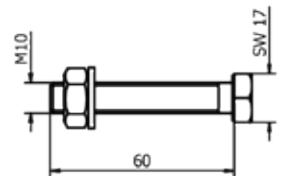

<b>Model 6021</b>	<b>zinc-plated steel (inside)</b>	<b>AISI 316 (exterior)</b>
-------------------	-----------------------------------	----------------------------

Art. no.
----------

91.6021.060.81
----------------

Art. no.
----------

91.6021.060.30
----------------

## Mounting set for wood



- | Finish interior application: zinc-plated steel (inside)
- | Required number per 2500 mm: 13 pieces
- | M12
- | Sales unit: 13 pieces

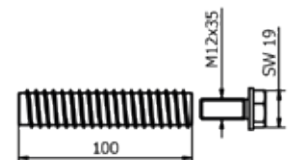

<b>Model 6021</b>	<b>zinc-plated steel (inside)</b>
-------------------	-----------------------------------

Art. no.
----------

91.6021.800.81
----------------



# TL-6021 | 1.0 KN SIDE MOUNT

## Screw anchor for concrete



- | Suitable for our profiles without countersinking
- | Finish interior application: Zinc-plated steel (interior) HUS3-H 10x90
- | Finish exterior application: V4A (outside) HUS3-HR 10x95
- | Tangential screwdriver required

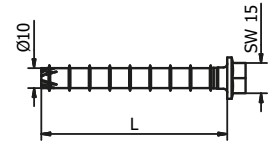

Model 3701	zinc-plated steel (inside)	Model 3701	AISI 316 (exterior)
Sales unit	Art. no.	Sales unit	Art. no.
50	91.3701.090.81	25	91.3701.095.30

## FLEXFIT 1.0 KN



- | Fine adjustment of glass panes
- | For glass thicknesses between 12 - 21.52 mm
- | Adjustment of up to 34 mm in relation to the vertical axis
- | Pay attention to the right glass thickness!

Length		2500 mm	5000 mm	25 mtr
Glass thickness	Wedge colour	Art. no.	Art. no.	Art. no.
12 mm	black	90.0502.112.00	90.0505.112.00	90.0525.112.00
6/6/2 (12.76 mm)	red	90.0502.113.00	90.0505.113.00	90.0525.113.00
6/6/4 (13.52 mm)	grey	90.0502.114.00	90.0505.114.00	90.0525.114.00
15 mm	yellow	90.0502.115.00	90.0505.115.00	90.0525.115.00
<b>8/8/2 (16.76 mm)</b>	red	90.0502.117.00	90.0505.117.00	90.0525.117.00
<b>8/8/4 (17.52 mm)</b>	green	90.0502.118.00	90.0505.118.00	90.0525.118.00
19 mm	blue	90.0502.119.00	90.0505.119.00	90.0525.119.00
<b>10/10/2 (20.76 mm)</b>	red	90.0502.121.00	90.0505.121.00	90.0525.121.00
<b>10/10/4 (21.52 mm)</b>	green	90.0502.122.00	90.0505.122.00	90.0525.122.00

# DRAINAGE – BUT NOT A RAIN GUTTER.

If water and cold combine, this can lead to problems when using all-glass balustrades. For this purpose, all **ONLEVEL** glass support profiles are equipped with drainage holes with a distance of 1000 mm between each of them. And we wouldn't be **ONLEVEL**, if we hadn't thought of all sorts of situations. Depending on the season, the balustrade can be subject to the most different influences (e.g.: leaves, sand, dirt).

**We offer the only profile of this kind on the market.**

**ONLEVEL** has paid special attention to ensure that the pivot point of the glass is on the same level as the rubber seals – therefore the rubber seals are never directly subjected to an increased or decreased load. As a result, dirt affects the balustrade much less.

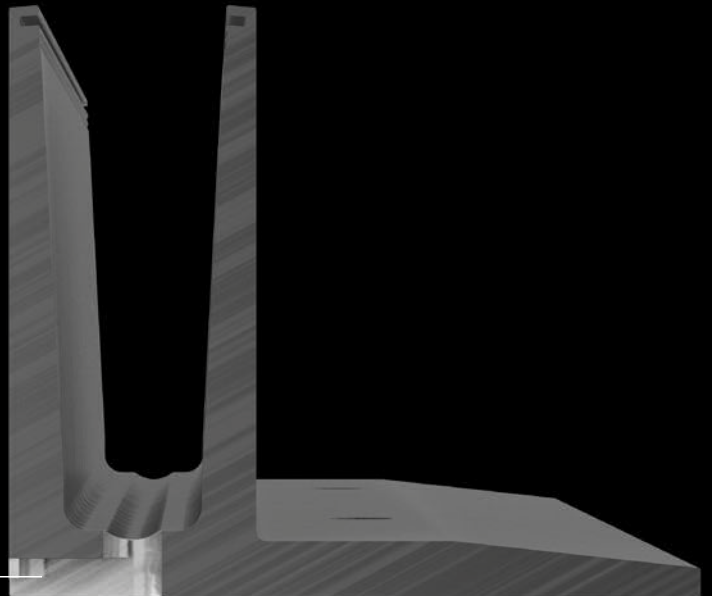

# TL-6030

3.0 kN Top Mount

## Fat Sister.

The TL-6030 U-profile HD is not only cost-effective. There is much more to it. This profile is especially popular for completely concealed installations. When used together with the structural connection profiles, its application versatility increases many times over.

As a matter of fact, the profile is suited both for interior and exterior applications. It can withstand a linear load of 3.0 kN and is appropriate for glass thicknesses between 21.52 mm and 31.52 mm.

## Essential Features

- | Slimline, elegant design and low-maintenance
- | ONLEVEL FLEXFIT Glass Adjustment Tool
- | Drainage holes
- | For glass thicknesses between 21.52 - 31.52 mm
- | For applications in the public area



TESTED  
according to  
BS6180

CE EN1090-1  
EN1090-3  
EXC 3

riba  
product  
selector

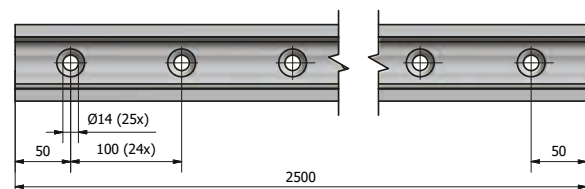
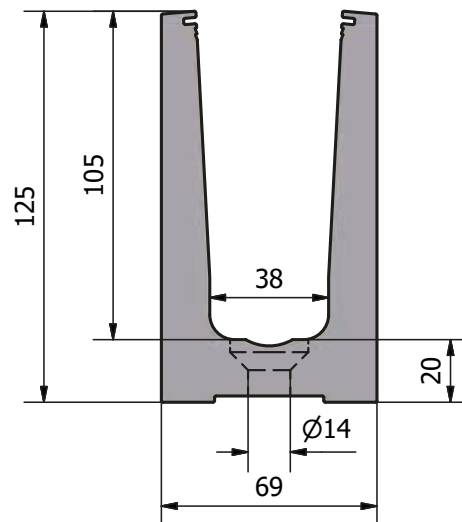
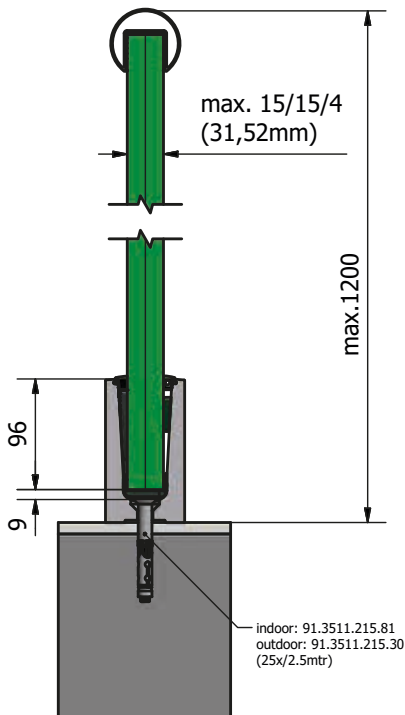



Unlimited application  
versatility

Fat but still nearly invisible



Especially for applications in  
the public area



Top mount



# TL-6030 | 3.0 KN TOP MOUNT

## Glass profile



- | Height: 125 mm
- | Width: 69 mm
- | Sales unit: 1 piece

Model 6030	Plain aluminium
Length	Art. no.
2500	10.6030.002.11

## Inside corner / outside corner 90°



- | Side length inside: 131 mm
- | Side length outside: 200 mm
- | Sales unit: 1 piece

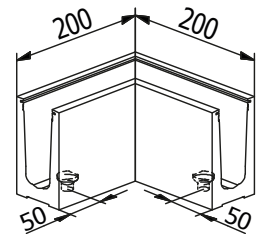

Model 6030	Plain aluminium
	Art. no.
	10.6030.390.11

## End cap, left/right



- | For use on the left and right
- | Sales unit: 1 piece

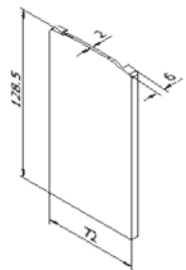

Model 6030	Plain aluminium
Application	Art. no.
left/right	10.6030.490.11

## Fischer fixing anchor FH II 12/15 SK



- | Finish interior application: zinc-plated steel (inside)
- | Finish exterior application: V4A (exterior)
- | Required number per 2500 mm: 25 pieces
- | Sales unit: 25 pieces

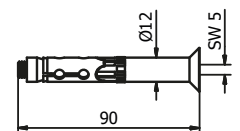

Model 3511	zinc-plated steel (inside)	AISI 316 (exterior)
	Art. no.	Art. no.
	91.3511.215.81	91.3511.215.30

# TL-6030 | 3.0 KN TOP MOUNT

## Fixing anchor steel



- | Finish interior application: zinc-plated steel (inside)
- | Finish exterior application: V4A (exterior)
- | Required number per 2500 mm: 25 pieces
- | M10 x 40 mm
- | Sales unit: 17 pieces

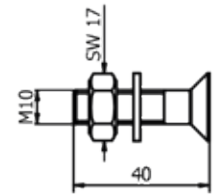

Model 6030	zinc-plated steel (inside)	AISI 316 (exterior)
	Art. no.	Art. no.
	91.6030.040.81	91.6030.040.30

## FLEXFIT 3.0 kN



- | Fine adjustment of glass panes
- | For glass thicknesses between 21.52 - 31.52 mm
- | Adjustment of up to 34 mm in relation to the vertical axis
- | Pay attention to the right glass thickness!

Length		2500 mm	5000 mm	25 mtr
Glass thickness	Wedge colour	Art. no.	Art. no.	Art. no.
10/10/4 (21.52 mm)	blue	90.0502.322.00	90.0505.322.00	90.0525.322.00
12/12/4 (25.52 mm)	red	90.0502.326.00	90.0505.326.00	90.0525.326.00
15/15/4 (31.52 mm)	green	90.0502.332.00	90.0505.332.00	90.0525.332.00

# TL-6031

3.0 kN Side Mount

## Big Brother.

The TL-6031 U-profile HD is an intelligent solution, especially for installations without screed onto steel or concrete.

As a matter of fact, the profile is suited both for interior and exterior applications. It can withstand a linear load of 3.0 kN and is appropriate for glass thicknesses between 21.52 mm and 31.52 mm. With TL-6031 you prove your farsightedness.

## Essential Features

- | Slimline, elegant design and low-maintenance
- | ONLEVEL FLEXFIT Glass Adjustment Tool
- | Extension pin holes
- | Drainage holes
- | Top Cover (optional)
- | Integrated multifunctional sophisticated chamber
- | For glass thicknesses between 21.52 - 31.52 mm



TESTED  
according to  
BS6180

CE EN1090-1  
EN1090-3  
EXC 3

riba  
product  
selector

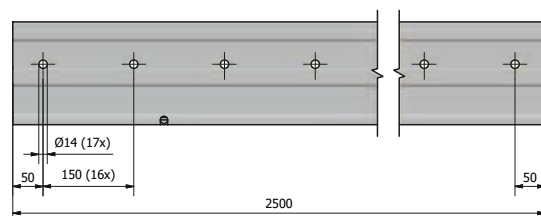
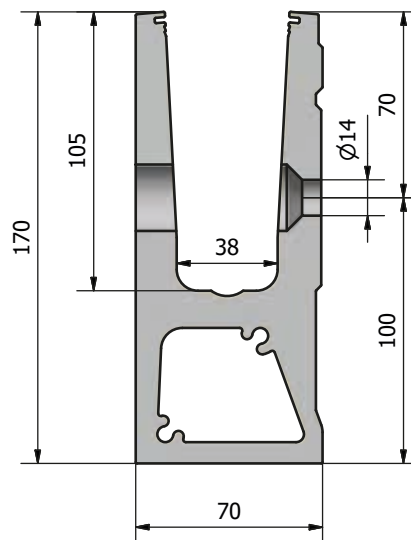
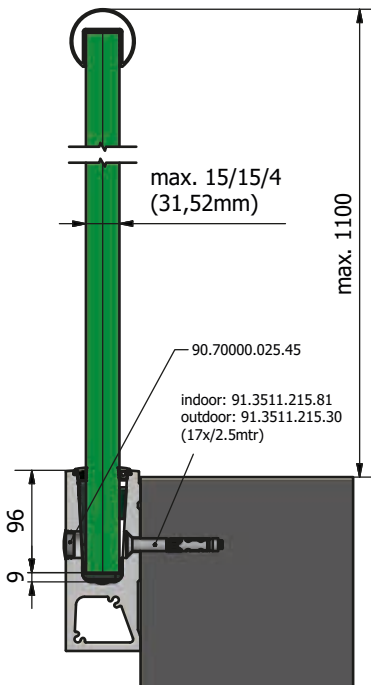





Mount directly onto steel  
or concrete

Suitable for extreme  
loads



Side mount

Integrated multifunctional  
sophisticated chamber for  
enabling larger drilling  
distances



# TL-6031 | 3.0 KN SIDE MOUNT

## Glass profile



| Height: 170 mm  
| Width 70 mm  
| Sales unit: 1 piece

Model 6031	Plain aluminium
Length	Art. no.
2500	10.6031.002.11

## Inside corner 90°



| Side length inside: 130 mm  
| Side length outside: 200 mm  
| Sales unit: 1 piece

Model 6031	Plain aluminium
	Art. no.
	10.6031.300.11

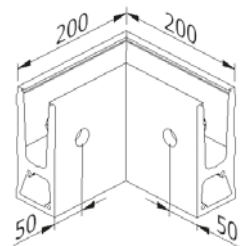

## Outside corner 90°



| Side length inside: 130 mm  
| Side length outside: 200 mm  
| Sales unit: 1 piece

Model 6031	Plain aluminium
	Art. no.
	10.6031.350.11

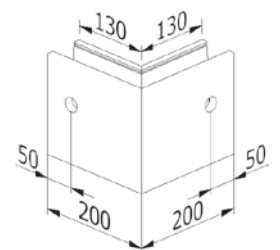

## End cap, left



| For use on the left  
| Sales unit: 1 piece

Model 6031	Plain aluminium
Application	Art. no.
left	10.6031.400.11

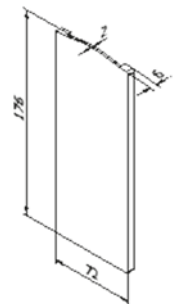

# TL-6031 | 3.0 KN SIDE MOUNT

## End cap, right



| For use on the right  
| Sales unit: 1 piece

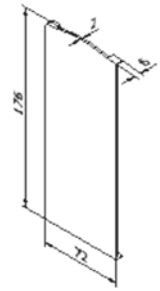

<b>Model 6031</b>	<b>Plain aluminium</b>
Application	Art. no.
right	10.6031.450.11

## End cap with cover strip, left



| For use on the left  
| Sales unit: 1 piece

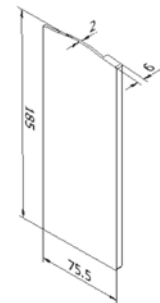

<b>Model 6031</b>	<b>Plain aluminium</b>
Application	Art. no.
left	10.6031.410.11

## End cap with cover strip, right



| For use on the right  
| Sales unit: 1 piece



<b>Model 6031</b>	<b>Plain aluminium</b>
Application	Art. no.
right	10.6031.460.11

## Cover strip



| With mounting strips  
| For use with a cover cap, end caps must be ordered separately.  
| Sales unit: 1 piece

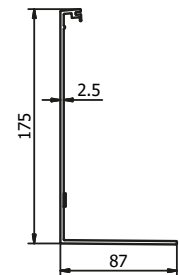

<b>Model 6031</b>	<b>Plain aluminium</b>
Length	Art. no.
5000	10.6031.205.11

# TL-6031 | 3.0 KN SIDE MOUNT

## Extension pin



- | Length: 40 mm
- | Diameter: Ø 6 mm
- | Sales unit: 8 piece

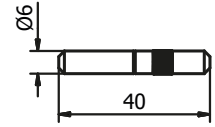

Model 7001	AISI 316 (inside & outside)
	Art. no.
	90.7001.640.31

## Blanking plug



- | Required number per 2500 mm: 17 pieces
- | Sales unit: 10 pieces

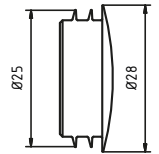

Model 7000	Plastic	
Colour	Diameter	Art. no.
white	25 mm	90.7000.025.40
black	25 mm	90.7000.025.41
grey	25 mm	90.7000.025.45

## Fischer fixing anchor FH 12/15 SK



- | Finish interior application: zinc-plated steel (inside)
- | Finish exterior application: V4A (exterior)
- | Required number per 2500 mm: 17 pieces
- | Sales unit: 25 pieces

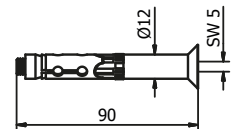

Model 3511	zinc-plated steel (inside)	AISI 316 (exterior)
	Art. no.	Art. no.
	91.3511.215.81	91.3511.215.30

## Fixing anchor steel



- | Finish interior application: zinc-plated steel (inside)
- | Finish exterior application: V4A (exterior)
- | Required number per 2500 mm: 17 pieces
- | M10 x 40mm
- | Sales unit: 17 pieces

Model 6031	zinc-plated steel (inside)	AISI 316 (exterior)
	Art. no.	Art. no.
	91.6031.040.81	91.6031.040.30

# TL-6031 | 3.0 KN SIDE MOUNT

## Mounting set for wood



- | Finish interior application: zinc-plated steel (inside)
- | Required number per 2500 mm: 17 pieces
- | M12
- | Sales unit: 17 pieces

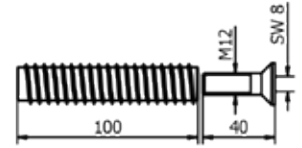

<b>Model 6031</b>	<b>zinc-plated steel (inside)</b>
Art. no.	
91.6031.800.81	



## FLEXFIT 3.0 kN



- | Fine adjustment of glass panes
- | For glass thicknesses between 21.52 - 31.52 mm
- | Adjustment of up to 34 mm in relation to the vertical axis
- | Pay attention to the right glass thickness!

Length		2500 mm	5000 mm	25 mtr
Glass thickness	Wedge colour	Art. no.	Art. no.	Art. no.
10/10/4 (21.52 mm)	blue	90.0502.322.00	90.0505.322.00	90.0525.322.00
12/12/4 (25.52 mm)	red	90.0502.326.00	90.0505.326.00	90.0525.326.00
15/15/4 (31.52 mm)	green	90.0502.332.00	90.0505.332.00	90.0525.332.00

# TL-6040

0.8kN - 1.6kN Top Mount



MADE FOR  
SWITZERLAND

## Eat this.

The U Profile HD TL-6040 is a good bloke. Now you don't only save installation time but can start your BBQ even earlier. Thanks to the use of anchor bolts, you save cash when compared to the standard countersunk head anchors. In addition, this greatly increases the adjustment facilities when mounting the profile.

In addition, TL-6040 is especially suited for non-tempered glass - therefore problems with the evenness of the glass are a thing of the past.

## Essential Features

- | Slimline, elegant design and low-maintenance
- | ONLEVEL FLEXFIT Glass Adjustment Tool
- | Drainage holes
- | Extension pin holes
- | For glass thicknesses between 21.52 - 31.52 mm
- | For applications in the public area



**TESTED**  
according to  
**SIA 261**

**TESTED**  
according to  
**BS6180**

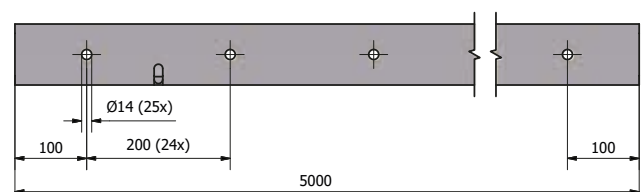
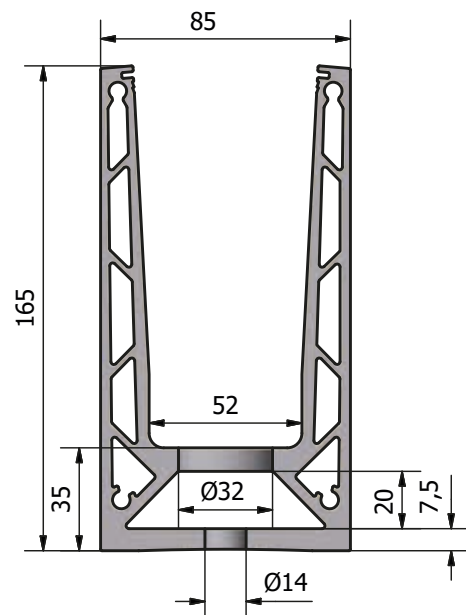
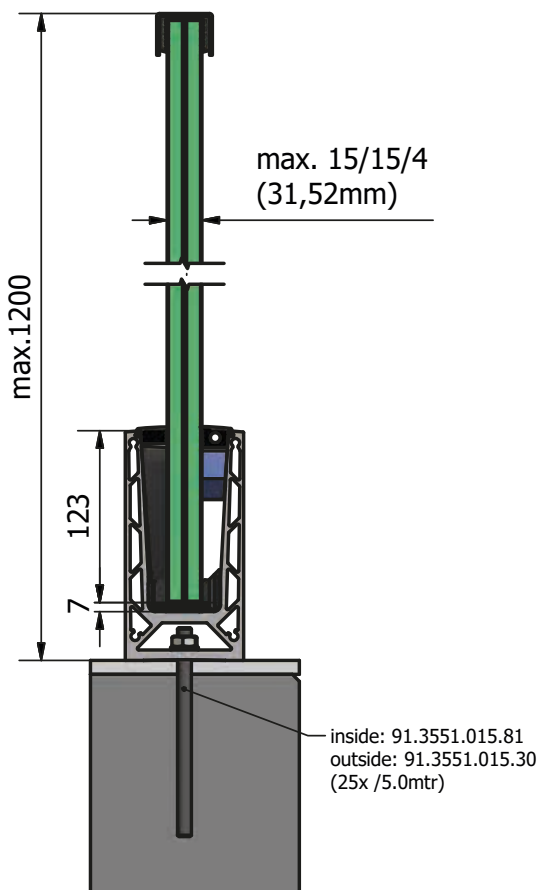



Suitable for laminated safety glass made of float glass

Fat but still nearly invisible



Especially for applications in the public area



Top mount

# TL-6040 | 0.8KN - 1.6 KN TOP MOUNT

## Glass profile



- | Height 165 mm
- | Width 85 mm
- | Sales unit: 1 piece

Model 6040	Mill finish	Plain aluminium	RAL coloured
Length	Art. no.	Art. no.	Art. no.
5000	10.6040.005.10	10.6040.005.11	10.6040.005.13/16/18

## Inside corner / outside corner 90°



- | Side length inside 130 mm
- | Side length outside 200 mm
- | Sales unit: 1 piece

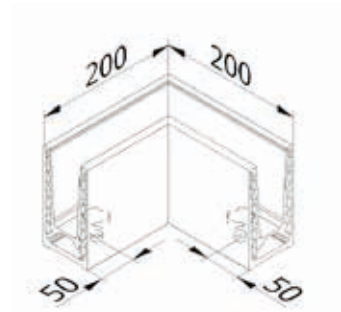

Model 6040	Mill finish	Plain aluminium	RAL coloured
	Art. no.	Art. no.	Art. no.
	10.6040.390.10	10.6040.390.11	10.6040.390.13/16/18

## End cap, left/right



- | For use on the left and right
- | Sales unit: 1 piece

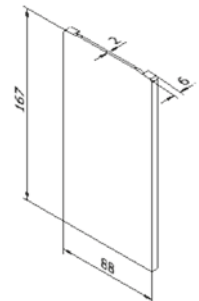

Model 6040	Mill finish	Plain aluminium	RAL coloured
Application	Art. no.	Art. no.	Art. no.
left/right	10.6040.490.10	10.6040.490.11	10.6040.490.13/16/18

## Fischer fixing anchor FIS AM M10x150



- | Finish interior application: zinc-plated steel (inside)
- | Finish exterior application: V4A (exterior)
- | Required number per 5000 mm: 25 pieces
- | Injection mortar (91.3000.010.00) is sufficient for ± 26 anchors
- | Sales unit: 10 pieces

**fischer** 

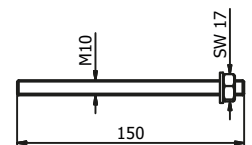

Model 3551	zinc-plated steel (inside)	AISI 316 (exterior)
	Art. no.	Art. no.
	91.3551.015.81	91.3551.015.30



# TL-6040 | 0.8KN - 1.6KN TOP MOUNT

## Extension pin



- | Length: 40 mm
- | Diameter: Ø 6 mm
- | Sales unit: 8 piece

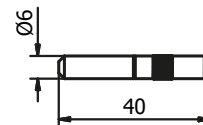

**Model 7001**    **AISI 316 (inside & outside)**

Art. no.

90.7001.640.31

## Mounting set for steel



- | Finish interior application: zinc-plated steel (inside)
- | Finish exterior application: V4A (exterior)
- | Required number per 5000 mm: 25 pieces
- | M10 x 60 mm
- | Sales unit: 25 pieces

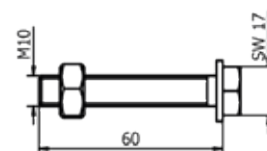

**Model 6040**    **Zinc-plated steel (interior)**    **AISI 316 (outside)**

Art. no.

Art. no.

91.6040.040.81

91.6040.040.30

## Screw anchor for concrete



- | Suitable for our profiles without countersinking
- | Finish interior application: Zinc-plated steel (interior) HUS3-H 10x90
- | Finish exterior application: V4A (outside) HUS3-HR 10x95
- | Tangential screwdriver required

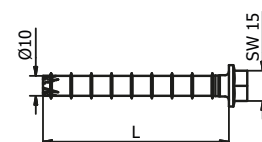

**Model 3701**    **zinc-plated steel (inside)**    **Model 3701**    **AISI 316 (exterior)**

Sales unit

Art. no.

Sales unit

Art. no.

50

91.3701.090.81

25

91.3701.095.30

## FLEXFIT DEEP 1.5 kN



- | Fine adjustment of glass panes
- | For glass thicknesses between 21.52 - 31.52 mm
- | Adjustment of up to 34 mm in relation to the vertical axis
- | Pay attention to the right glass thickness!
- | Attention: Use FlexFit Deep Tool 90.0100.115.00

Length		2500 mm	5000 mm	12.5 mtr
Glass thickness	Wedge colour	Art. no.	Art. no.	Art. no.
10/10/4 (21.52 mm)	blue	90.0502.422.00	90.0505.422.00	90.0512.422.00
12/12/4 (25.52 mm)	red	90.0502.426.00	90.0505.426.00	90.0512.426.00
15/15/4 (31.52 mm)	green	90.0502.432.00	90.0505.432.00	90.0512.432.00

# TL-6041

0.8kN - 1.6kN Side Mount



MADE FOR  
SWITZERLAND

## Holy Häschen.

You can't teach an old dog new tricks? Wrong. What works on top can also be used on the side. The TL-6041 profile runs like a Swiss clockwork. Developed specifically for the USA and the Alpine region for extremely high loads and efficient installation. Save time and take your advantage.

In addition, TL-6041 is especially suited for non-tempered glass - therefore problems with the evenness of the glass are a thing of the past.

## Essential Features

- | Slimline, elegant design and low-maintenance
- | ONLEVEL FLEXFIT Glass Adjustment Tool
- | Extension pin holes
- | Drainage holes
- | Top Cover (optional)
- | Integrated multifunctional sophisticated chamber
- | For glass thicknesses between 21,52 - 31,52 mm



**TESTED**  
according to  
**SIA 261**

**TESTED**  
according to  
**BS6180**

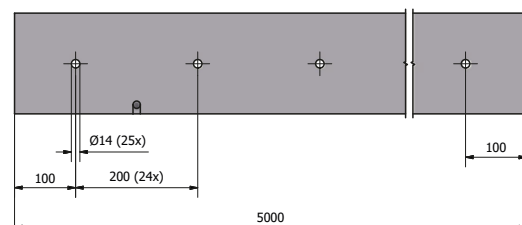
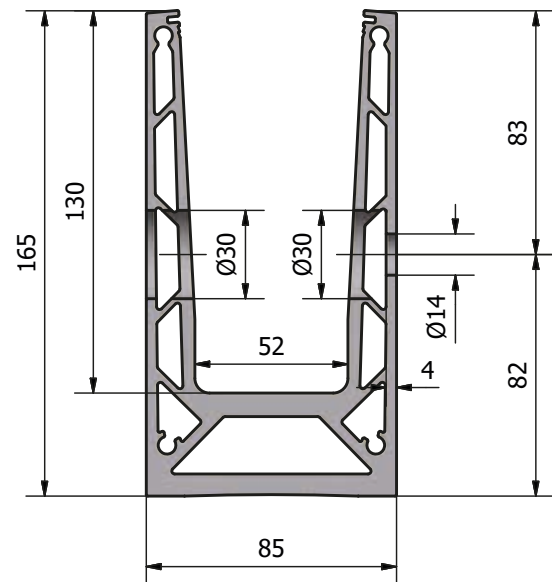
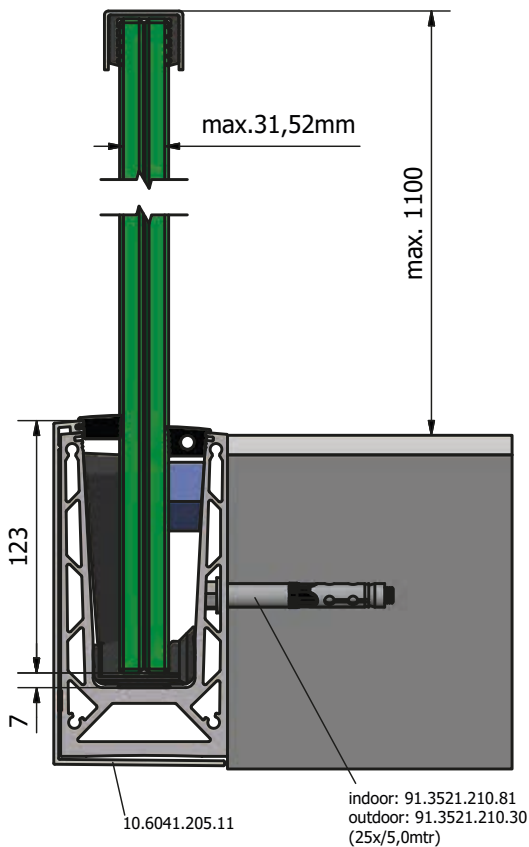



Mount directly onto steel  
or concrete

Suitable for laminated safety  
glass made of float glass



M12 thread: adjustment  
of the profile with screws  
possible

Integrated multifunctional  
sophisticated chamber for  
enabling larger drilling distances

# TL-6041 | 0.8KN - 1.6KN SIDE MOUNT

## Glass profile



| Height: 165 mm  
| Width: 85 mm  
| Sales unit: 1 piece

Model 6041	Mill finish	Plain aluminium	RAL coloured
Length	Art. no.	Art. no.	Art. no.
5000	10.6041.005.10	10.6041.005.11	10.6041.005.13/16/18

## Inside corner 90°



| Side length inside 115 mm  
| Side length outside 200 mm  
| Sales unit: 1 piece

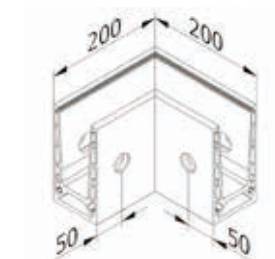

Model 6041	Mill finish	Plain aluminium	RAL coloured
	Art. no.	Art. no.	Art. no.
	10.6041.300.10	10.6041.300.11	10.6041.300.13/16/18

## Outside corner 90°



| Side length inside 115 mm  
| Side length outside 200 mm  
| Sales unit: 1 piece

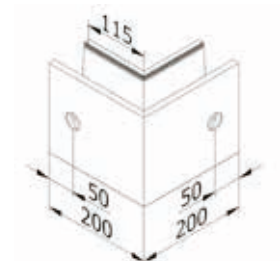

Model 6041	Mill finish	Plain aluminium	RAL coloured
	Art. no.	Art. no.	Art. no.
	10.6041.350.10	10.6041.350.11	10.6041.350.13/16/18

## End cap, left



| For use on the left  
| Sales unit: 1 piece

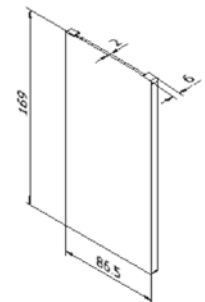

Model 6041	Mill finish	Plain aluminium	RAL coloured
Application	Art. no.	Art. no.	Art. no.
left	10.6041.400.10	10.6041.400.11	10.6041.400.13/16/18

# TL-6041 | 0.8KN - 1.6KN SIDE MOUNT

## End cap, right



| For use on the right  
| Sales unit: 1 piece

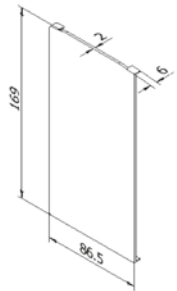

Model 6041	Mill finish	Plain aluminium	RAL coloured
Application	Art. no.	Art. no.	Art. no.
right	10.6041.450.10	10.6041.450.11	10.6041.450.13/16/18

## End cap, left, with cover cap



| For use on the left  
| Sales unit: 1 piece

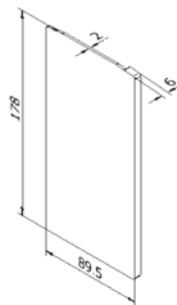

Model 6041	Mill finish	Plain aluminium	RAL coloured
Application	Art. no.	Art. no.	Art. no.
left	10.6041.410.10	10.6041.410.11	10.6041.410.13/16/18

## End cap, right, with cover cap



| For use on the right  
| Sales unit: 1 piece

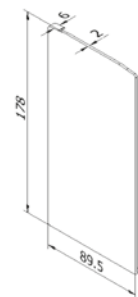

Model 6041	Mill finish	Plain aluminium	RAL coloured
Application	Art. no.	Art. no.	Art. no.
right	10.6041.460.10	10.6041.460.11	10.6041.460.13/16/18

## Cover strip



| With mounting strips  
| For use with a cover cap, end caps must be ordered separately.  
| Sales unit: 1 piece



Model 6041	Mill finish	Plain aluminium	RAL coloured
Length	Art. no.	Art. no.	Art. no.
5000	10.6041.2050.10	10.6041.205.11	10.6041.205.13/16/18

# TL-6041 | 0.8KN - 1.6KN SIDE MOUNT

## Fischer fixing anchor FH II 12/10



- | Finish interior application: zinc-plated steel (inside)
- | Finish exterior application: V4A (exterior)
- | Required number per 2500 mm: 13 pieces
- | Sales unit: 50 pieces

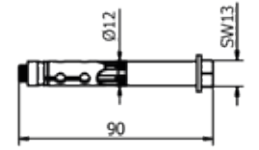

Model 3521	zinc-plated steel (inside)	AISI 316 (exterior)
	Art. no.	Art. no.
	91.3521.210.81	91.3521.210.30

## Mounting set for steel



- | Finish interior application: zinc-plated steel (inside)
- | Finish exterior application: V4A (exterior)
- | Required number per 2500 mm: 13 pieces
- | M10 x 60 mm
- | Sales unit: 13 pieces

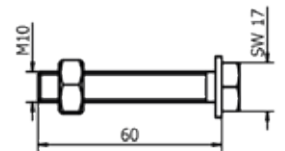

Model 6041	zinc-plated steel (inside)	AISI 316 (exterior)
	Art. no.	Art. no.
	91.6041.060.81	91.6041.060.30

## Mounting set for wood



- | Finish interior application: zinc-plated steel (inside)
- | Required number per 2500 mm: 13 pieces
- | M12
- | Sales unit: 13 pieces

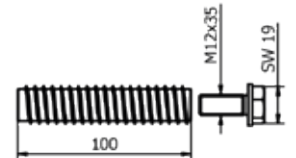

Model 6041	zinc-plated steel (inside)
	Art. no.
	91.6041.800.81



## Screw anchor for concrete



- | Suitable for our profiles without countersinking
- | Finish interior application: Zinc-plated steel (interior) HUS3-H 10x90
- | Finish exterior application: V4A (outside) HUS3-HR 10x95
- | Tangential screwdriver required

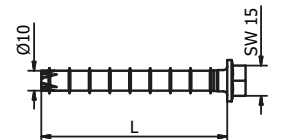

Model 3701	zinc-plated steel (inside)	Model 3701	AISI 316 (exterior)
Sales unit	Art. no.	Sales unit	Art. no.
50	91.3701.090.81	25	91.3701.095.30

# TL-6041 | 0.8KN - 1.6KN SIDE MOUNT

## FLEXFIT DEEP 1.5 KN



- | Fine adjustment of glass panes
- | For glass thicknesses between 21.52 - 31.52 mm
- | Adjustment of up to 34 mm in relation to the vertical axis
- | Pay attention to the right glass thickness!
- | Attention: Use FlexFit Deep Tool 90.0100.115.00

Length		2500 mm	5000 mm	12.5 mtr
Glass thickness	Wedge colour	Art. no.	Art. no.	Art. no.
10/10/4 (21.52 mm)	blue	90.0502.422.00	90.0505.422.00	90.0512.422.00
12/12/4 (25.52 mm)	red	90.0502.426.00	90.0505.426.00	90.0512.426.00
15/15/4 (31.52 mm)	green	90.0502.432.00	90.0505.432.00	90.0512.432.00

# TL-6500

0.5 kN Top Mount

## The attika model.

The TL-6500 profile is designed to be particularly small and slim. The impressive thing about it is that it withstands such high loads in spite of its reduced model dimensions. The top mount model is especially suited for use on parapet walls.

The profile can withstand a linear load of 0.5 kN and is suitable for glass thicknesses between 10 mm and 17.52 mm.

## Essential Features

- | Slimline, elegant design and low-maintenance
- | ONLEVEL FLEXFIT Glass Adjustment Tool
- | Extension pin channel
- | Drainage holes
- | Optimally suited for concrete upstand
- | For glass thicknesses between 10 - 17.52 mm

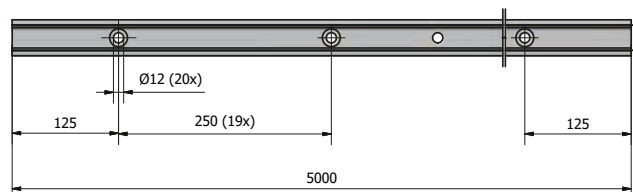
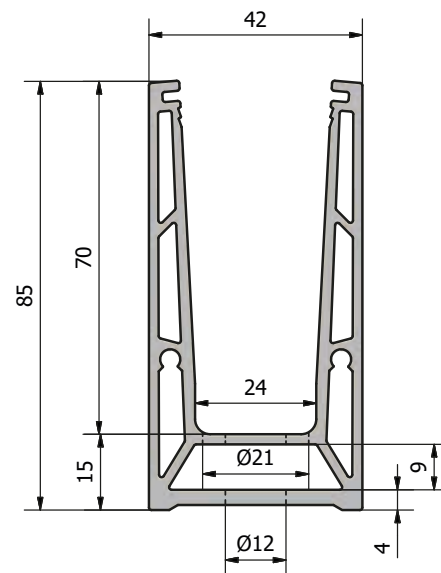
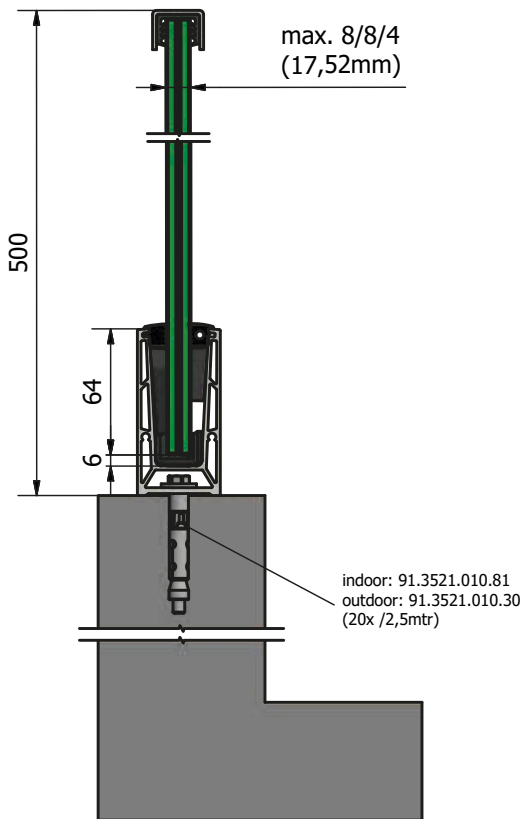





Optimally suited for  
concrete upstand

Top Cover and  
Floor Connect



Top mount

# TL-6500 | 0.5 KN TOP MOUNT

## Glass profile



| Height: 85 mm  
| Width: 42 mm  
| Sales unit: 1 piece

Model 6500	Mill finish	Plain aluminium	RAL coloured
Length	Art. no.	Art. no.	Art. no.
5000	10.6500.005.10	10.6500.005.11	10.6500.005.13/16/18

## Inside corner / outside corner 90°



| Side length inside: 158 mm  
| Side length outside: 200 mm  
| Sales unit: 1 piece

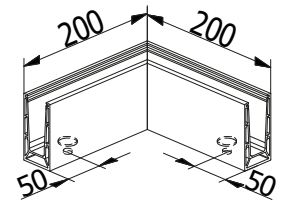

Model 6500	Mill finish	Plain aluminium	RAL coloured
	Art. Nr.	Art. Nr.	Art. Nr.
	10.6500.390.10	10.6500.390.11	10.6500.390.13/16/18

## End cap, left/right



| For use on the left and right  
| Sales unit: 1 piece

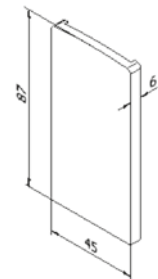

Model 6500	Mill finish	Plain aluminium	RAL coloured
Application	Art. Nr.	Art. Nr.	Art. Nr.
left/right	10.6500.490.10	10.6500.490.11	10.6500.490.13/16/18

## Extension pin



| Length: 40 mm  
| Diameter: Ø 4 mm  
| Sales unit: 8 piece

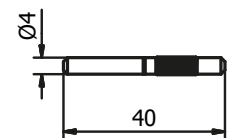

Model 7001	AISI 316 (inside & outside)
	Art. no.
	90.7001.440.31

# TL-6500 | 0.5 KN TOP MOUNT

## Fischer fixing anchor FH II 12/10



- | Finish interior application: zinc-plated steel (inside)
- | Finish exterior application: V4A (exterior)
- | Required number per 2500 mm: 10 pieces
- | Sales unit: 50 pieces

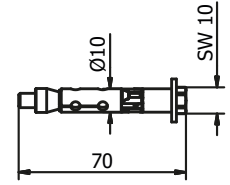

Model 3521	zinc-plated steel (inside)	AISI 316 (exterior)
	Art. no.	Art. no.
	91.3521.210.81	91.3521.210.30

## Mounting set for steel



- | Finish interior application: zinc-plated steel (inside)
- | Finish exterior application: V4A (exterior)
- | Required number per 2500 mm: 10 pieces
- | M10 x 60 mm
- | Sales unit: 10 pieces

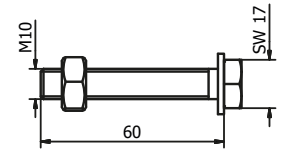

Model 6500	zinc-plated steel (inside)	AISI 316 (exterior)
	Art. no.	Art. no.
	91.6500.060.81	91.6500.060.30

## Mounting set for wood



- | Finish interior application: zinc-plated steel (inside)
- | Required number per 2500 mm: 13 pieces
- | M10
- | Sales unit: 10 pieces

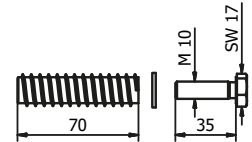

Model 6500	zinc-plated steel (inside)
	Art. no.
	91.6500.800.81



## FLEXFIT 0.5 KN



- | Fine adjustment of glass panes
- | For glass thicknesses between 12.76 - 17.52 mm
- | Adjustment of up to 34 mm in relation to the vertical axis
- | Pay attention to the right glass thickness!

Length		2500 mm	5000 mm	25 mtr
Glass thickness	Wedge colour	Art. no.	Art. no.	Art. no.
10 mm	red	90.0502.010.00	90.0505.010.00	90.0525.010.00
5/5/2 (10.76 mm)	red	90.0502.011.00	90.0505.011.00	90.0525.011.00
12 mm	red	90.0502.012.00	90.0505.012.00	90.0525.012.00
6/6/2 (12.76 mm)	red	90.0502.013.00	90.0505.013.00	90.0525.013.00
8/8/2 (16.76 mm)	red	90.0502.017.00	90.0505.017.00	90.0525.017.00
8/8/4 (17.52 mm)	green	90.0502.018.00	90.0505.018.00	90.0525.018.00

# TL-6501

0.5 kN Side Mount

## The side mounting model.

The TL-6501 is the counterpart to the TL-6500 for side mounting for parapet walls.. With its height of 85 mm, it also has model dimensions and is predestined for glass thicknesses between 10 and 17.52 mm in 0.5 kN applications.

The slimline profile is optimally suited for concrete upstand and is equipped with an extension pin channel and drainage holes.

## Essential Features

- | Slimline, elegant design and low-maintenance
- | ONLEVEL FLEXFIT Glass Adjustment Tool
- | Extension pin channel
- | Drainage holes
- | Optimally suited for concrete upstand
- | For glass thicknesses between 10 - 17.52 mm

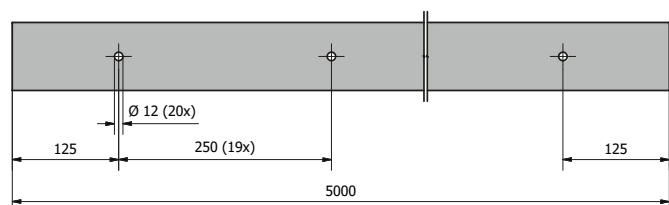
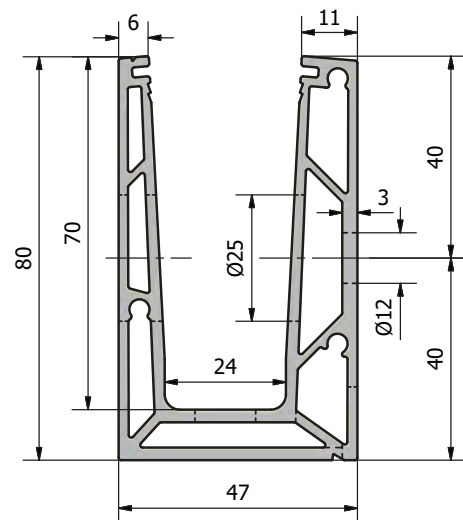
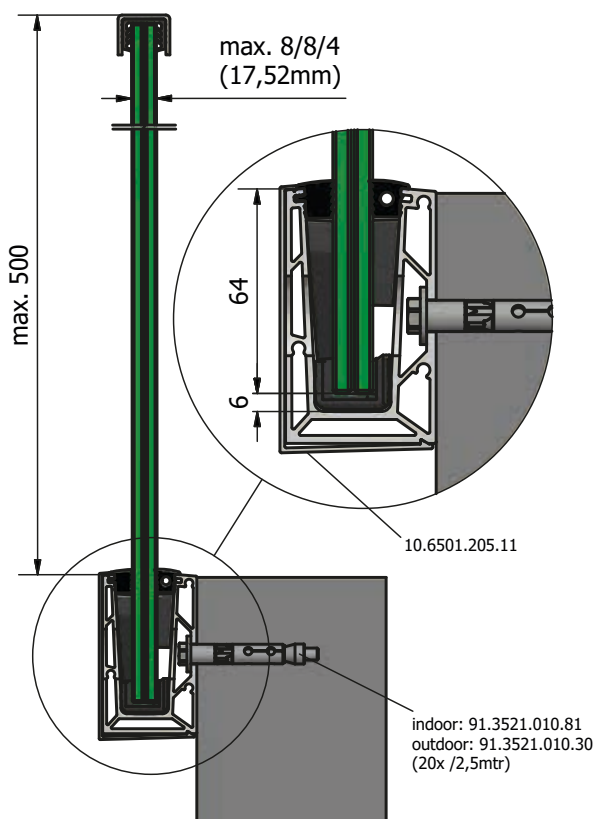



Optimally suited for  
concrete upstand

Top Cover and  
Floor Connect



Side mount

# TL-6501 | 0.5 KN SIDE MOUNT

## Glass profile

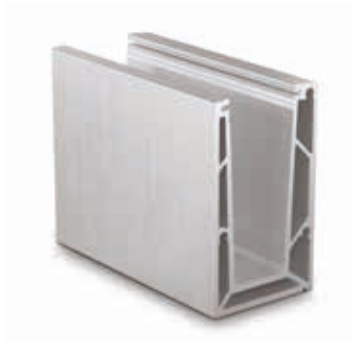

| Height: 80 mm  
| Width 47 mm  
| Sales unit: 1 piece

Model 6501	Mill finish	Plain aluminium	RAL coloured
Length	Art. no.	Art. no.	Art. no.
5000	10.6501.005.10	10.6501.005.11	10.6501.005.13/16/18

## Inside corner 90°



| Side length inside: 153 mm  
| Side length outside: 200 mm  
| Sales unit: 1 piece

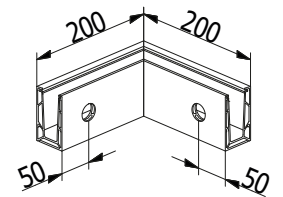

Model 6501	Mill finish	Plain aluminium	RAL coloured
	Art. no.	Art. no.	Art. no.
	10.6501.300.10	10.6501.300.11	10.6501.300.13/16/18

## Outside corner 90°



| Side length inside: 153 mm  
| Side length outside: 200 mm  
| Sales unit: 1 piece

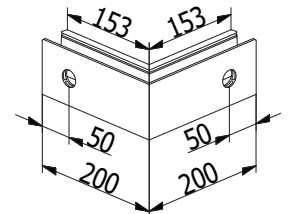

Model 6501	Mill finish	Plain aluminium	RAL coloured
	Art. no.	Art. no.	Art. no.
	10.6501.350.10	10.6501.350.11	10.6501.350.13/16/18

## Cover strip



| With mounting strips  
| For use with a cover cap, end caps must be ordered separately.  
| Sales unit: 1 piece

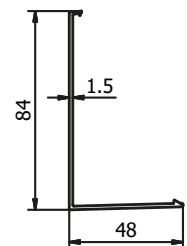

Model 6501	Mill finish	Plain aluminium	RAL coloured
Length	Art. no.	Art. no.	Art. no.
5000	10.6501.205.10	10.6501.205.11	10.6501.205.13/16/18

# TL-6501 | 0.5 KN SIDE MOUNT

## End cap, left



| For use on the left  
| Sales unit: 1 piece

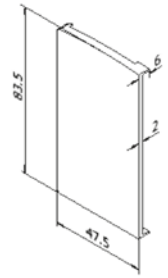

Model 6501	Mill finish	Plain aluminium	RAL coloured
Application	Art. no.	Art. no.	Art. no.
left	10.6501.400.10	10.6501.400.11	10.6501.400.13/16/18

## End cap, left, with cover cap



| For use on the left  
| Sales unit: 1 piece

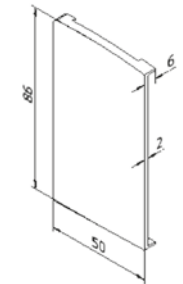

Model 6501	Mill finish	Plain aluminium	RAL coloured
Application	Art. no.	Art. no.	Art. no.
left	10.6501.410.10	10.6501.410.11	10.6501.410.13/16/18

## End cap, right

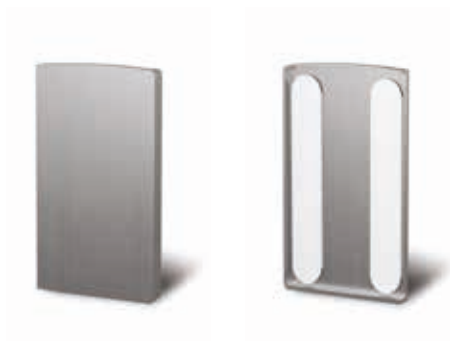

| For use on the right  
| Sales unit: 1 piece

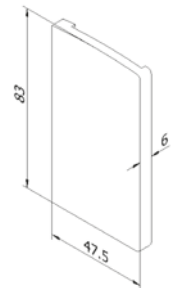

Model 6501	Mill finish	Plain aluminium	RAL coloured
Application	Art. no.	Art. no.	Art. no.
right	10.6501.450.10	10.6501.450.11	10.6501.450.13/16/18

## End cap, right, with cover cap



| For use on the right  
| Sales unit: 1 piece

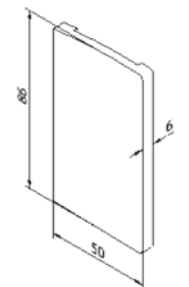

Model 6501	Mill finish	Plain aluminium	RAL coloured
Application	Art. no.	Art. no.	Art. no.
right	10.6501.460.10	10.6501.460.11	10.6501.460.13/16/18

# TL-6501 | 0.5 KN SIDE MOUNT

## Fischer fixing anchor FH II 12/10



- | Finish interior application: zinc-plated steel (inside)
- | Finish exterior application: V4A (exterior)
- | Required number per 2500 mm: 10 pieces
- | Sales unit: 50 pieces

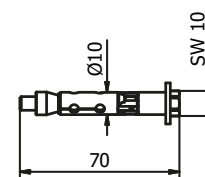

Model 3521	zinc-plated steel (inside)	AISI 316 (exterior)
	Art. no.	Art. no.
	91.3521.210.81	91.3521.210.30

## Mounting set for steel



- | Finish interior application: zinc-plated steel (inside)
- | Finish exterior application: V4A (exterior)
- | Required number per 2500 mm: 10 pieces
- | M10 x 60 mm
- | Sales unit: 10 pieces

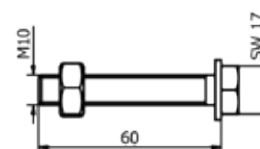

Model 6501	zinc-plated steel (inside)	AISI 316 (exterior)
	Art. no.	Art. no.
	91.6501.060.81	91.6501.060.30

## Mounting set for wood



- | Finish interior application: zinc-plated steel (inside)
- | Required number per 2500 mm: 13 pieces
- | M10
- | Sales unit: 10 pieces

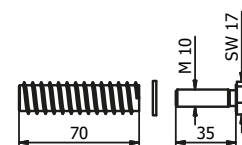

Model 6501	zinc-plated steel (inside)
	Art. no.
	91.6501.800.81



## FLEXFIT 0.5 KN



- | Fine adjustment of glass panes
- | For glass thicknesses between 12.76 - 17.52 mm
- | Adjustment of up to 34 mm in relation to the vertical axis
- | Pay attention to the right glass thickness!

Length		2500 mm	5000 mm	25 mtr
Glass thickness	Wedge colour	Art. no.	Art. no.	Art. no.
10 mm	red	90.0502.010.00	90.0505.010.00	90.0525.010.00
5/5/2 (10.76 mm)	red	90.0502.011.00	90.0505.011.00	90.0525.011.00
12 mm	red	90.0502.012.00	90.0505.012.00	90.0525.012.00
6/6/2 (12.76 mm)	red	90.0502.013.00	90.0505.013.00	90.0525.013.00
8/8/2 (16.76 mm)	red	90.0502.017.00	90.0505.017.00	90.0525.017.00
8/8/4 (17.52 mm)	green	90.0502.018.00	90.0505.018.00	90.0525.018.00



# PERFECT FIT. PERFECT PRICE.



FLEXFIT is the perfect system for the fine adjustment of glass panes. With FLEXFIT you can adjust any glass pane individually while positioning it up to 34 mm in relation to the vertical axis.

## Ready.

With only one simple sliding movement, you can adjust the glass that precisely that 30% less mounting time is required. FLEXFIT is optionally available in all Translevel glass support profiles for thicknesses between 12 mm and 31.52 mm.

## Steady.

Standard systems often require installation on both the fall and the balcony sides. FLEXFIT can be handled exclusively from the balcony side. This applies for the entire installation process, by the way, which is not only much safer but also saves you unnecessary expenditures for a scaffold or lifting platform.

## Go.

ONLEVEL has developed the practical FLEXFIT system for quickly and perfectly adjusting glass panels: With one single move of your hand, you can adjust the glass with millimetric precision.

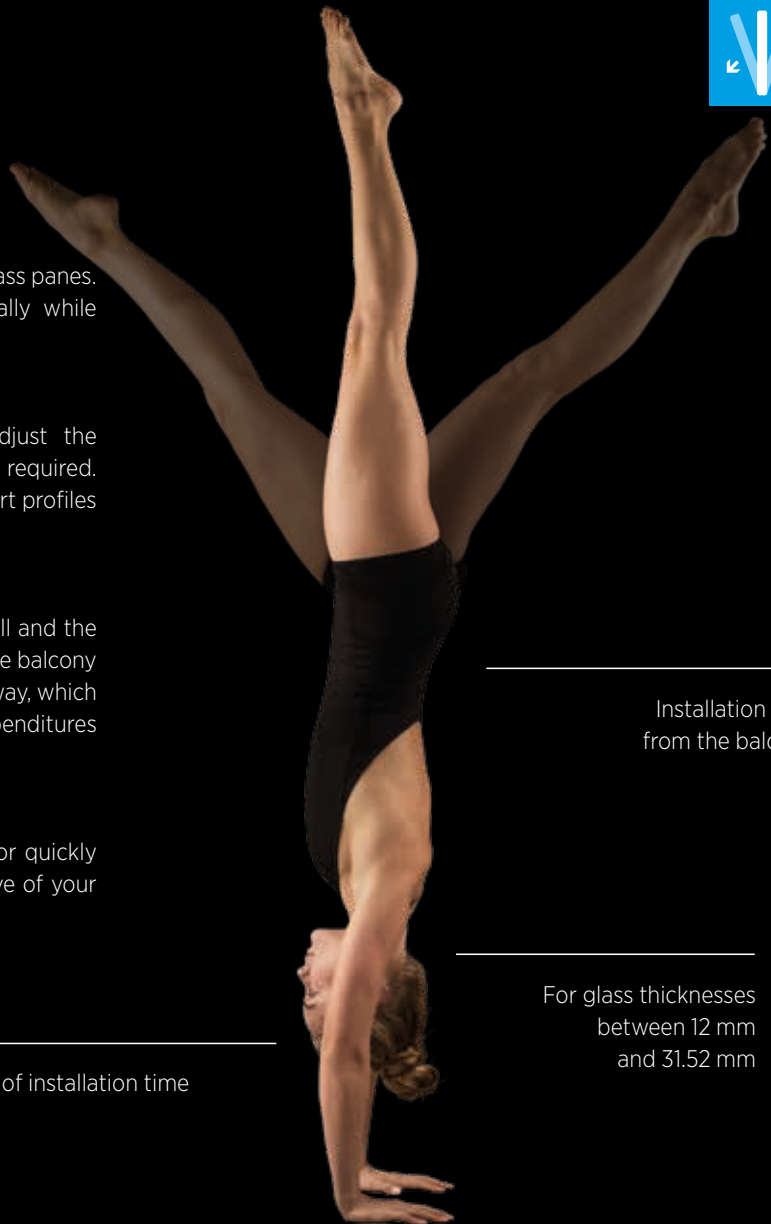

Installation only  
from the balcony  
side

For glass thicknesses  
between 12 mm  
and 31.52 mm

Saves 30% of installation time

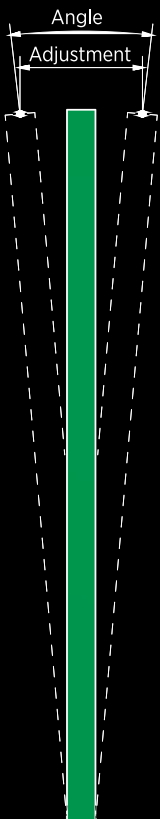

GLASS THICKNESS 0.74kN	ANGLE	GLASS HEIGHT 1000mm	GLASS HEIGHT 1100mm	GLASS HEIGHT 1200mm
		ADJUSTMENT	ADJUSTMENT	ADJUSTMENT
12 mm	1.6°	28 mm	30 mm	34 mm
12.76 mm (6/6/2)	1.6°	28 mm	30 mm	34 mm
13.52 mm (6/6/4)	1.6°	28 mm	30 mm	34 mm
15 mm	1.6°	28 mm	30 mm	34 mm
16.76 mm (8/8/2)	1.0°	28 mm	30 mm	34 mm
17.52 mm (8/8/4)	1.6°	28 mm	30 mm	34 mm
19 mm	1.0°	18 mm	20 mm	22 mm
20.76 mm (10/10/2)	1.0°	18 mm	20 mm	22 mm
21.52 mm (10/10/4)	1.0°	18 mm	20 mm	22 mm

GLASS THICKNESS 3.0kN	ANGLE	GLASS HEIGHT 1000mm	GLASS HEIGHT 1100mm	GLASS HEIGHT 1200mm
		ADJUSTMENT	ADJUSTMENT	ADJUSTMENT
21.52 mm (10/10/4)	1.0°	28 mm	30 mm	34 mm
25.52 mm (12/12/4)	1.6°	28 mm	30 mm	34 mm
31.52 mm (15/15/4)	1.0°	18 mm	20 mm	22 mm



Chlebny, s. r. o.

Jana Palacha / Devotyho 1625

530 02 Pardubice

Česká republika

t +420 46 66 34 170

e [info@chlebny.cz](mailto:info@chlebny.cz)

i [www.zabradlizeska.cz](http://www.zabradlizeska.cz)